



Fish eye Network Camera User Manual

Version: V7.1.18.3

Table of Contents

- ◆ STATEMENT4
- ◆ SAFETY INSTRUCTION4
- ◆ INTRODUCTION5
- 1. SYSTEM REQUIREMENT5
- 2. NETWORK CONNECTION5
 - 2.1. SETTING THE NETWORK CAMERA OVER THE LAN5
 - 2.1.1. Wiring over the LAN.....5
 - 2.1.2. Detecting and Changing the IP Address6
 - 2.2. SETTING THE NETWORK CAMERA OVER THE WAN6
 - 2.2.1. Static IP Connection.....7
 - 2.2.2. Dynamic IP Connection.....7
- 3. ACCESS TO THE NETWORK CAMERA BY CLIENT SOFTWARE.....8
- 4. ACCESS TO THE NETWORK CAMERA BY WEB CLIENT10
 - 4.1. PREPARATION BEFORE INSTALL.....10
 - 4.2. INSTALL THE HSWEBPLUGIN.EXE CONTROLS10
 - 4.3. INTERFACE OPERATIONS AND USAGE:.....14
 - 4.3.1. LOGIN14
 - 4.3.2. Live preview.....14
 - 4.3.2.1. Live View Page14
 - 4.3.2.2. Starting Live View.....16
 - 4.3.2.3. Recording and Capturing Pictures Manually17
 - 4.3.3. Operating PTZ Control17
 - 4.3.4. Setting / Calling a Preset18
 - 4.3.4.1. Setting a Preset:18
 - 4.3.4.2. Calling a Preset.....19
 - 4.4. NETWORK CAMERA CONFIGURATION20
 - 4.4.1. Local Configuration20
 - 4.4.2. System21
 - 4.4.2.1. System Configuration21
 - 4.4.2.2. Scheduled Reboot.....24
 - 4.4.2.3. Log Search24
 - 4.4.2.4. Security.....24
 - 4.4.2.5. SD Card.....25
 - 4.4.3. Network.....26
 - 4.4.3.1. Basic Setup26
 - 4.4.3.2. Advance Setup.....27
 - 4.4.4. Video31
 - 4.4.4.1. Video31
 - 4.4.4.2. Audio32
 - 4.4.5. Image33
 - 4.4.5.1. Image33
 - 4.4.5.2. OSD.....35
 - 4.4.6. Events35
 - 4.4.6.1. Motion Detection35
 - 4.4.6.2. Privacy37
 - 4.4.6.3. Video Tampering38
 - 4.4.6.4 Exception38
 - 4.5. Playback39

5. APP CLIENT41

- 5.1. *Download and install App* 41
- 5.2. *Add device* 41
- 5.3. *VR Preview*..... 42

6. FREQUENTLY ASKED QUESTIONS.....44

- 6.1. *WHY CAN NOT ACCESS THE CAMERA BY IE* 44
- 6.2. *WHY CAN NOT ACCESS THE CAMERA AFTER UPDATE?* 44
- 6.3. *WHY CANNOT SHOW THE WHOLE INTERFACE?* 44

◆ Statement

Thank you for purchasing our product. If there are any questions or requests, please do not hesitate to contact the dealer.

This manual applies to network fisheye camera.

This manual may contain several technical incorrect places or printing errors, and the content is subject to change without notice. The updates will be added to the new version of this manual. We will readily improve or update the products or procedures described in the manual.

◆ Please pay your attention to exceptions below:

- Should any reasons below cause the product destroyed or service stop, we will assume no responsibility for your or third party's personal injury and property loss: ① No installation or use according to instruction strictly. ② For sake of state-building maintenance or public interest. ③ Cases of force majeure. ④ Your personal or third party reasons. (Include no limitation use of third party's products, software or components)
- Our company has never guaranteed the products for improper or illegal purposes and uses. This product cannot be used as medical & safety devices or other applications that will cause danger or injury. And loss or responsibility caused by above uses, you must bear it by yourself.
- With correct installation and use, this product can detect the illegal intrusion, but it can not avoid accidents and personal injury or property damage due to these accidents. Please be on the alert in your daily life, reinforce your safety awareness.
- Our company assume no responsibility for any indirect or occasional or special or punitive damages, request, property damage or any loss of data or file. Within the max scope of law allowed, our company's compensation is no more than the products amount you paid.

◆ Safety Instruction

This manual is intended to ensure that user can use the product properly without danger or any property loss. Please read it carefully and take care of it for further reference. Precaution measures are divided into "warnings" and "cautions", as below:

Warnings: Neglecting any of the warnings may cause death or serious injury.

Cautions: Neglecting any of the cautions may cause injury or equipment damage.

 <p>Warning Follow these safeguards to avoid death or serious injury</p>	 <p>Caution Follow these precautions to Prevent potential injury or Property loss</p>
---	--



Warning

Electrical safety regulations of the nation and the region must be strictly followed during installation or use.

- Please use the matched power adapter from standard company.
- Do not connect multiple IPCs with one single power adapter (Overload for adapter may lead to over-heat or fire hazard).
- Shut down the power while connecting or dismantling the device. Do not operate with power on.
- The device should be firmly fixed when installed onto the wall or beneath the ceiling.
- Shut down the power and unplug the power cable immediately when there is smoke, odor or noise rising from the IPC. Then contact the dealer or service center.
- Please contact the local dealer or latest service center when IPC works abnormally. Do not attempt to disassemble or modify the device yourself. (We shall shoulder no responsibility for problems caused by unauthorized repair or maintenance).



Cautions

- Make sure the power supply voltage is correct before using the camera.
- Do not drop the camera or subject it to physical shock.
- Do not touch sensor modules with fingers. If cleaning is necessary, use a clean cloth with a bit of ethanol

and wipe it gently. If the camera will not be used for an extended period of time, put on the lens cap to protect the sensor from dirt.

4. Do not aim the camera lens at the strong light such as sun or incandescent lamp. The strong light can cause fatal damage to the camera.
5. The sensor may be burned out by a laser beam, so when any laser equipment is being used, make sure that the surface of the sensor not be exposed to the laser beam.
6. Do not place the camera in extremely hot, cold temperatures (the operating temperature should be between -30°C ~ 60°C), dusty or damp environment, and do not expose it to high electromagnetic radiation.
7. To avoid heat accumulation, good ventilation is required for a proper operating environment.
8. Keep the camera away from water and any liquid.
9. While shipping, the camera should be packed in its original packing.
10. Improper use or replacement of the battery may result in hazard of explosion. Please use the manufacturer recommended battery type.

◆ Introduction

This manual describes in detail fisheye camera network connection, settings and web client and app client download, installation and interface operation.

1. System Requirement

Operating System: Microsoft Windows XP SP1 and above version / Vista / Win7 / Win 8 / Win 10 / Server 2003 / Server 2008 32bits

CPU: Intel Pentium IV 3.0 GHz or higher

RAM: 1G or higher

Display: 1024x768 resolution or higher

Web Browser: Internet Explorer 8 and above version, Safari 5.02 and above version, Mozilla Firefox 3.5 and above version and Google Chrome 4.5 and below version.

2. Network Connection

Before you start:

If you want to set the network camera via a LAN (Local Area Network), please refer to Section 2.1 Setting the Network Camera over the LAN.

If you want to set the network camera via a WAN (Wide Area Network), please refer to Section 2.2 Setting the Network Camera over the WAN.

2.1. Setting the Network Camera over the LAN

Purpose:

To view and configure the camera via a LAN, you need to connect the network camera in the same sub net with your computer, and install the IPC Search or [VMS](#) software to search and change the IP of the network camera.

2.1.1. Wiring over the LAN

The following figures show the two ways of cable connection of a network camera and a computer:

Purpose:

To test the network camera, you can directly connect the network camera to the computer with a network cable as below:

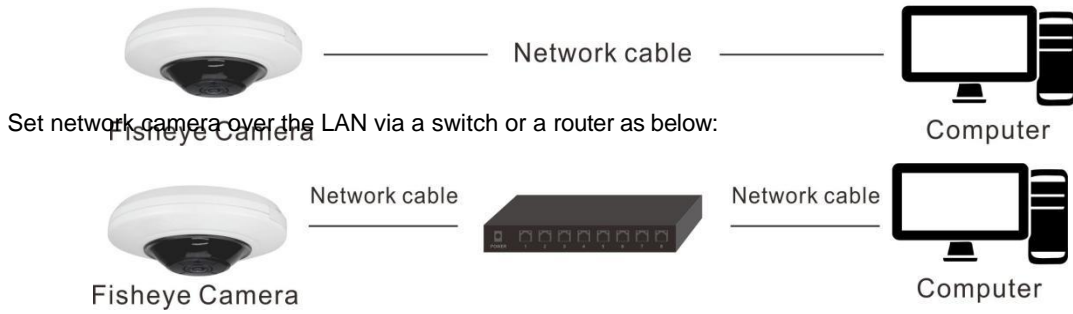

2.1.2. Detecting and Changing the IP Address

You need the IP address to visit the network camera.

Steps:

1. To get the IP address, you can choose either of the following methods:
 - ◆ Use IPC Search, a software tool which can automatically detect the online network cameras in the LAN and list the device information including IP address, sub net mask, port number, device serial number, device version, etc.as below.
 - ◆ Use the VMS client software to list the online devices. Please refer to the user manual of VMS client software for detailed information.
2. Change the IP address and sub net mask to the same sub net as that of your computer.
3. Enter the IP address of network camera in the address field of the web browser to view the live video.

Note:

- The default IP address is 192.168.1.168 and the port number is 80. The default user name is admin, and password is admin. And you are highly recommended change the initial password after your first login.
- For accessing the network camera from different sub nets, please set the gateway for the network camera after you logged in. For detailed information, please refer to Section 4.4.3.1 Configuring TCP/IP Settings.

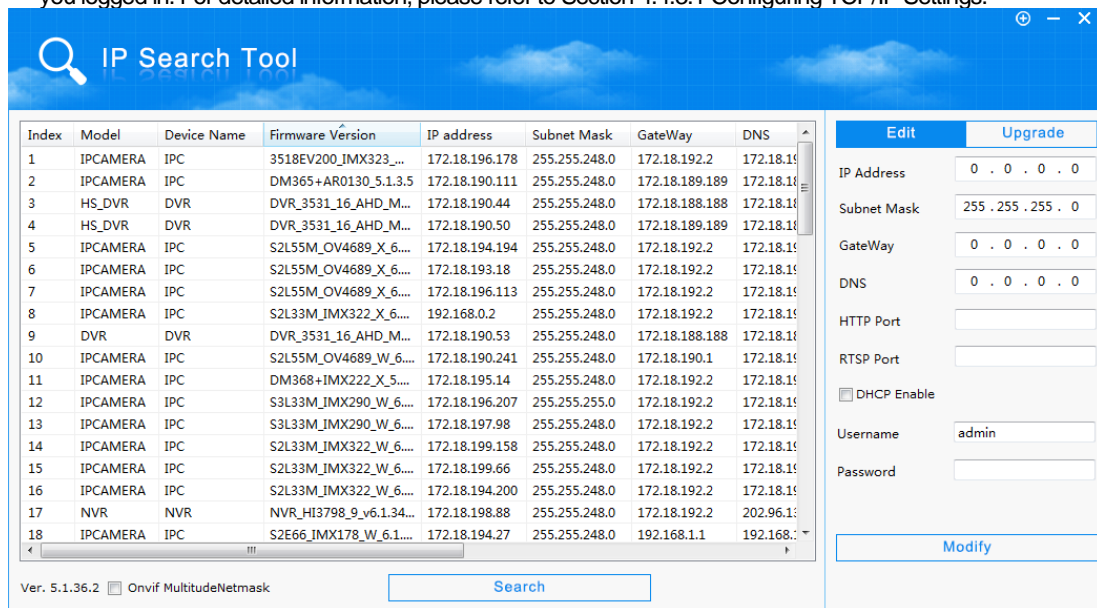

2.2. Setting the Network Camera over the WAN

Purpose:

This section explains how to connect the network camera to the WAN with a static IP or a dynamic IP.

2.2.1. Static IP Connection**Before you start:**

Please apply a static IP from an ISP (Internet Service Provider). With the static IP address, you can connect the network camera via a router or connect it to the WAN directly.

- **Connecting the network camera via a router**

Steps:

- (1) Connect the network camera to the router.
- (2) Assign a LAN IP address, the sub net mask and the gateway. Refer to *Section 2.1.2 Detecting and Changing the IP Address* for detailed IP address configuration of the camera.
- (3) Save the static IP in the router.
- (4) Set port mapping, e.g., 80, 8000, and 554 ports. The steps for port mapping vary according to the different routers. Please call the router manufacturer for assistance with port mapping.
- (5) Visit the network camera through a web browser or the client software over the internet.

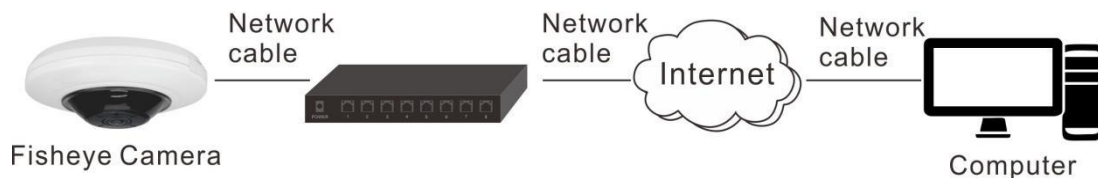

- **Connecting the network camera with static IP directly**

You can also save the static IP in the camera and directly connect it to the internet without using a router. Refer to *Section 2.1.2 Detecting and Changing the IP Address* for detailed IP address configuration of the camera.

**2.2.2. Dynamic IP Connection****Before you start:**

Please apply a dynamic IP from an ISP. With the dynamic IP address, you can connect the network camera to a modem or a router.

- **Connecting the network camera via a router**

Steps:

- (1) Connect the network camera to the router.
- (2) In the camera, assign a LAN IP address, the sub net mask and the gateway. Refer to *Section 2.1.2 Detecting and Changing the IP Address* for detailed LAN configuration.
- (3) In the router, set the PPPoE user name, password and confirm the password.
- (4) Set port mapping. E.g. 80, 8000, and 554 ports. The steps for port mapping vary depending on different routers. Please call the router manufacturer for assistance with port mapping.
- (5) Apply a domain name from a domain name provider.

(6) Configure the DDNS settings in the setting interface of the router.

(7) Visit the camera via the applied domain name.

Note: The obtained IP address is dynamically assigned via PPPoE, so the IP address always changes after rebooting the camera. To solve the inconvenience of the dynamic IP, you need to get a domain name from the DDNS provider (E.g. DynDns.com). Please follow the steps below for normal domain name resolution and private domain name resolution to solve the problem.

● Normal Domain Name Resolution

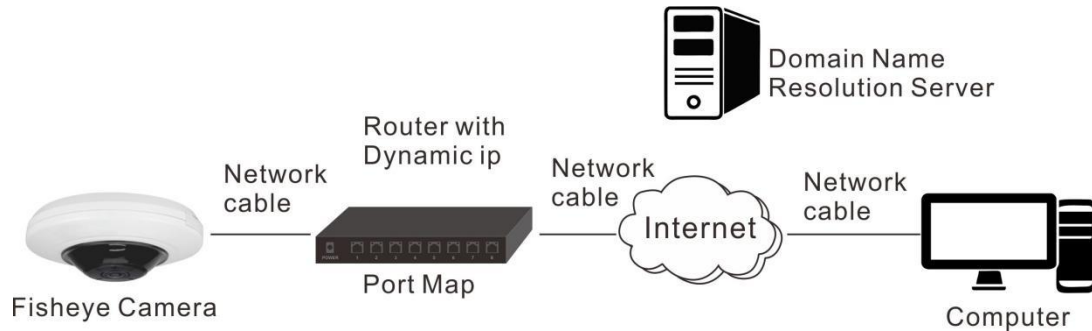

Steps:

- (1) Apply a domain name from a domain name provider.
- (2) Configure the DDNS settings in the DDNS Settings interface of the network camera. Refer to Section 4.4.3.2 Configuring DDNS Settings for detailed configuration.
- (3) Visit the camera via the applied domain name.

● Private Domain Name Resolution

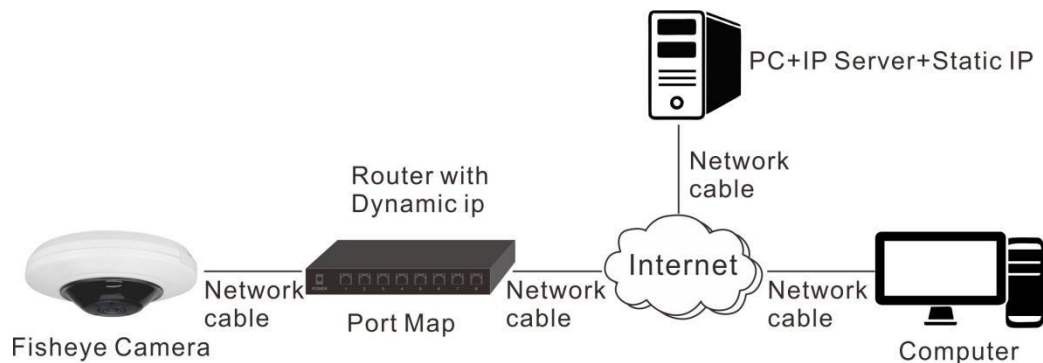

Steps:

- (1) Install and run the IP Server software in a computer with a static IP.
- (2) Access the network camera through the LAN with a web browser or the client software.
- (3) Enable DDNS and select IP Server as the protocol type. Refer to Section 5.3.4 Configuring DDNS Settings for detailed configuration.

3. Access to the Network Camera by Client Software

The product CD contains the VMS client software. You can view the live video and manage the camera with the software.

Follow the installation prompts to install the software. The control panel and live view interface of VMS

client software are shown as bellow.

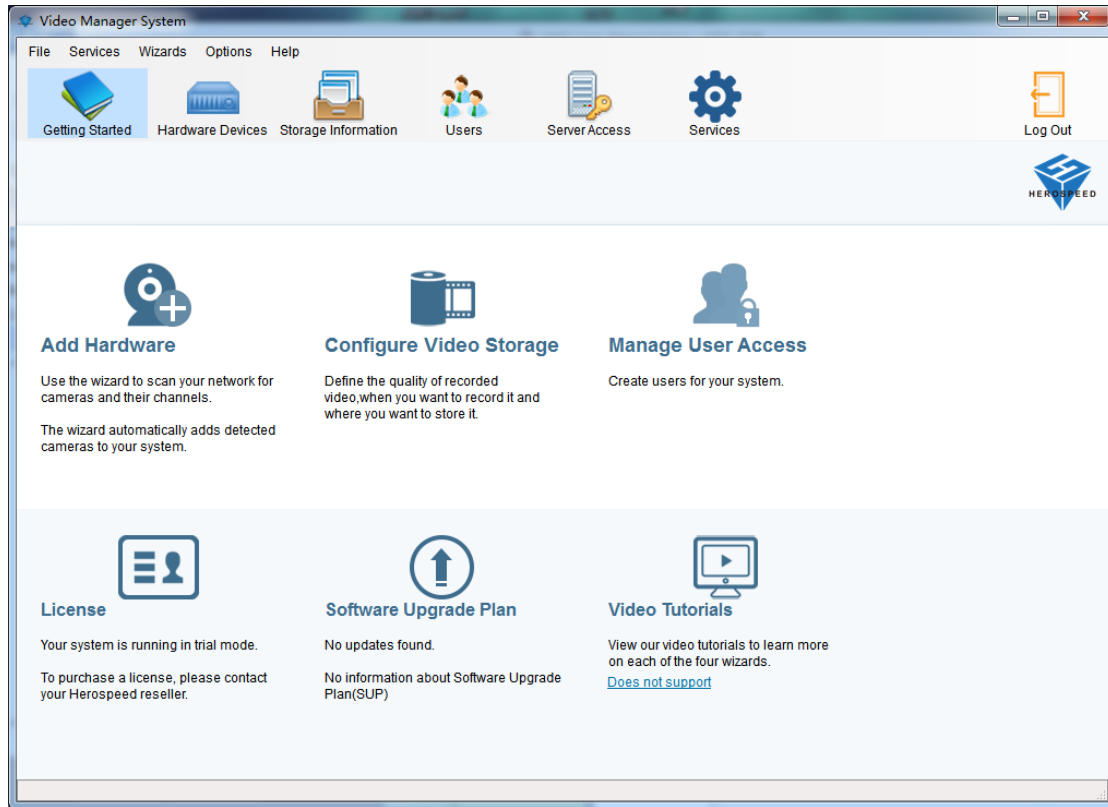

Note: For detailed information about the software, please refer to the user manual of the VMS Client Software.

4. Access to the Network Camera by Web Client

4.1. Preparation Before Install

In ensuring the IPC and the current user's computer after completion of all the hardware connection and power equipment normal, open the computer, run ping the IP address of the IPC (Note: the IP address of the IPC in LAN must be unique). Such as IPC IP for 192.168.1.168, run ping 192.168.1.168. If there is a response to the IPC as shown in the figure below, said the network connection is normal, you can download the plug-in.

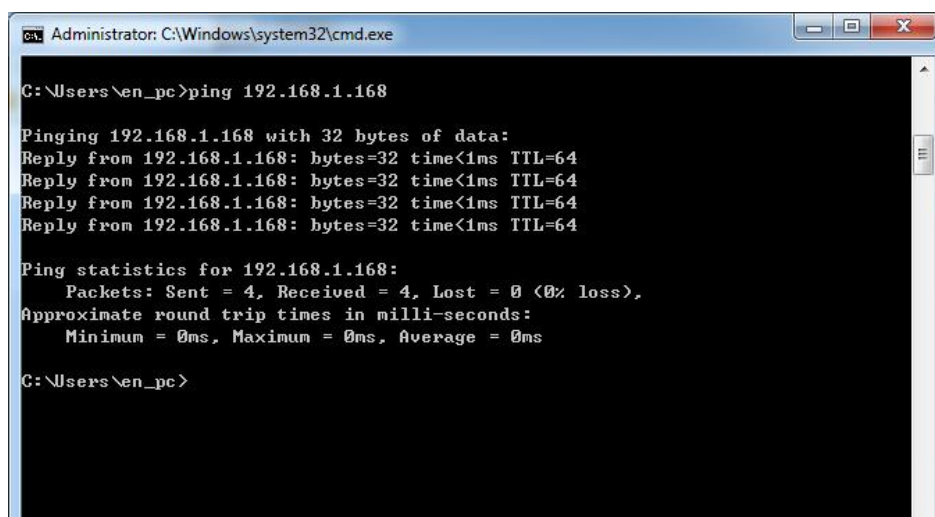

```
Administrator: C:\Windows\system32\cmd.exe
C:\Users\en_pc>ping 192.168.1.168

Pinging 192.168.1.168 with 32 bytes of data:
Reply from 192.168.1.168: bytes=32 time<1ms TTL=64
Reply from 192.168.1.168: bytes=32 time<1ms TTL=64
Reply from 192.168.1.168: bytes=32 time<1ms TTL=64
Reply from 192.168.1.168: bytes=32 time<1ms TTL=64

Ping statistics for 192.168.1.168:
    Packets: Sent = 4, Received = 4, Lost = 0 (0% loss),
    Approximate round trip times in milli-seconds:
        Minimum = 0ms, Maximum = 0ms, Average = 0ms

C:\Users\en_pc>
```

4.2. Install the HsWebplugin.exe Controls

Please open the IE browser and input the IP address of IPC in the address bar.(For the first time to use the default address is: <http://192.168.1.168>), you will be prompted to download information. As shown below:

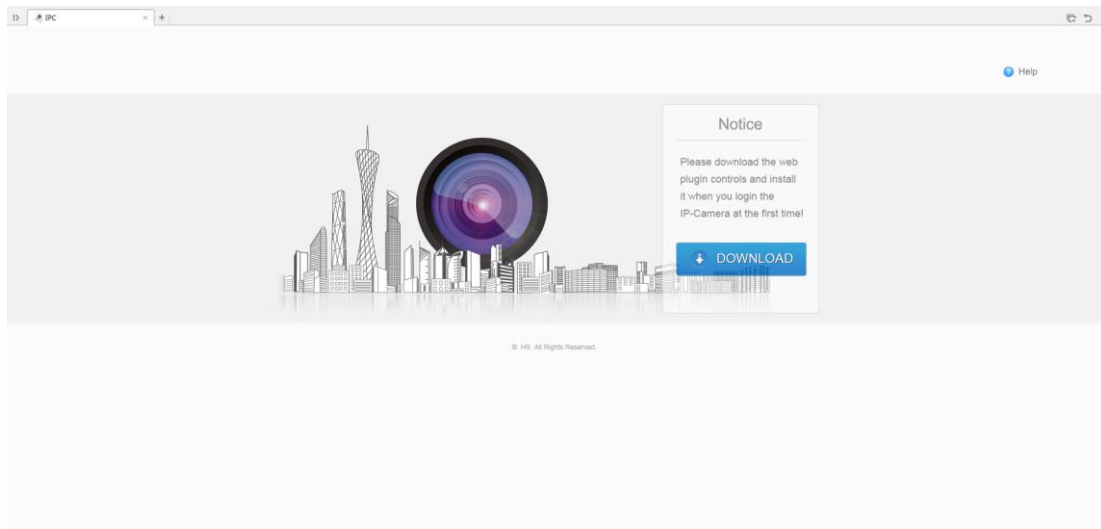

Click  to download, and you can choose "Run" or save directly the installation. As shown below: click "Run"

Will pop up the Setup Wizard after click "Run" , as shown below:



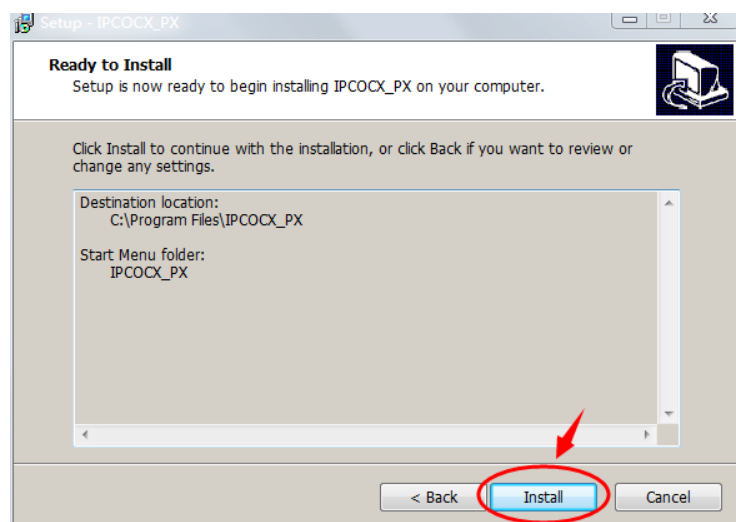
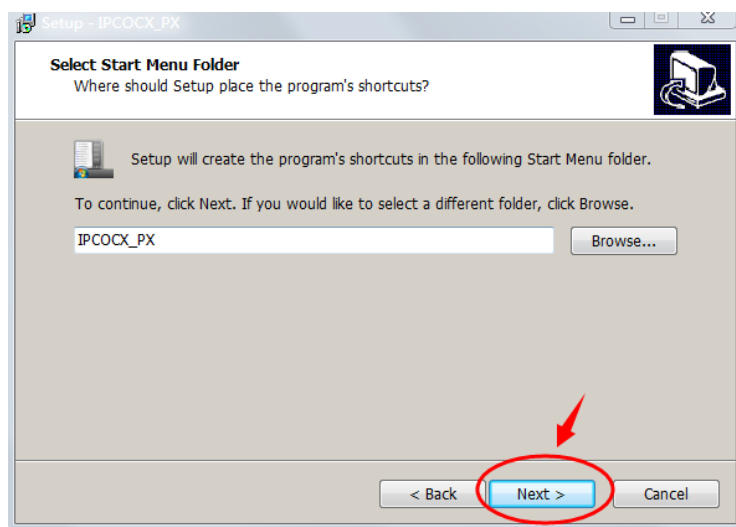
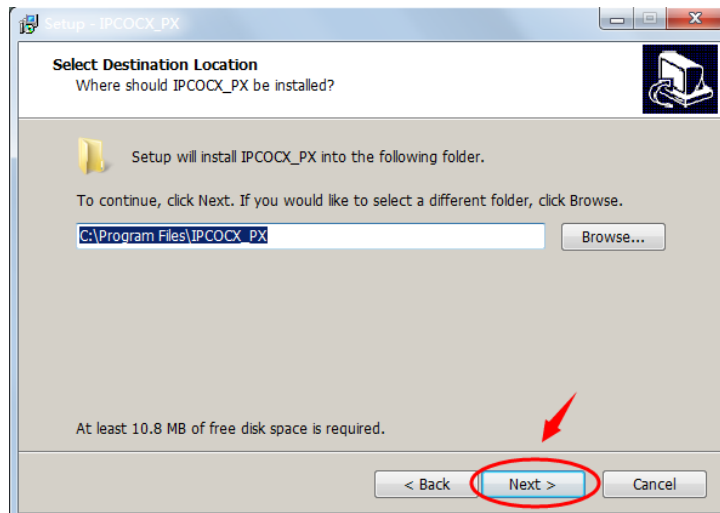

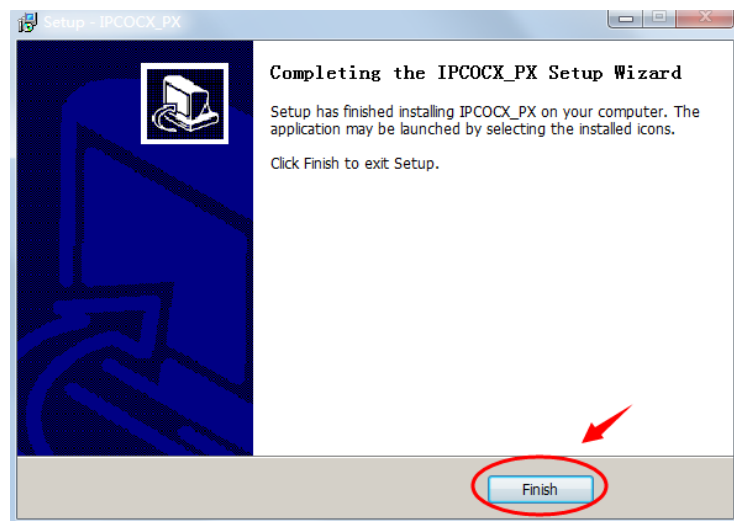
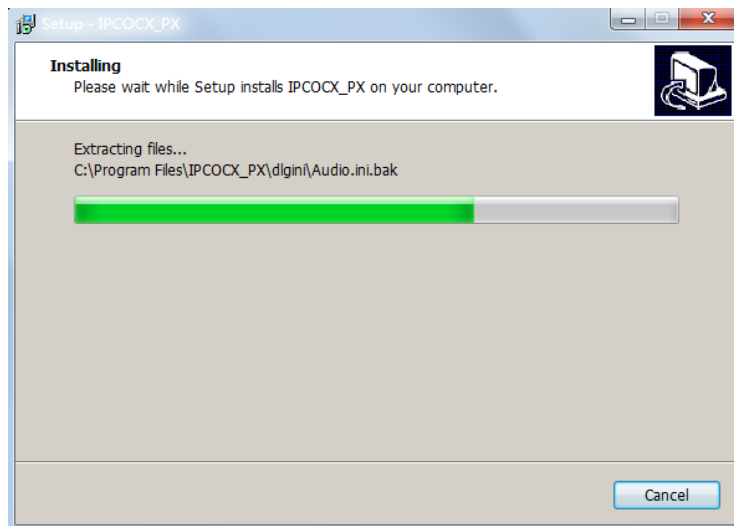

Click "Finish" and login page again, enter the login interface as shown below:

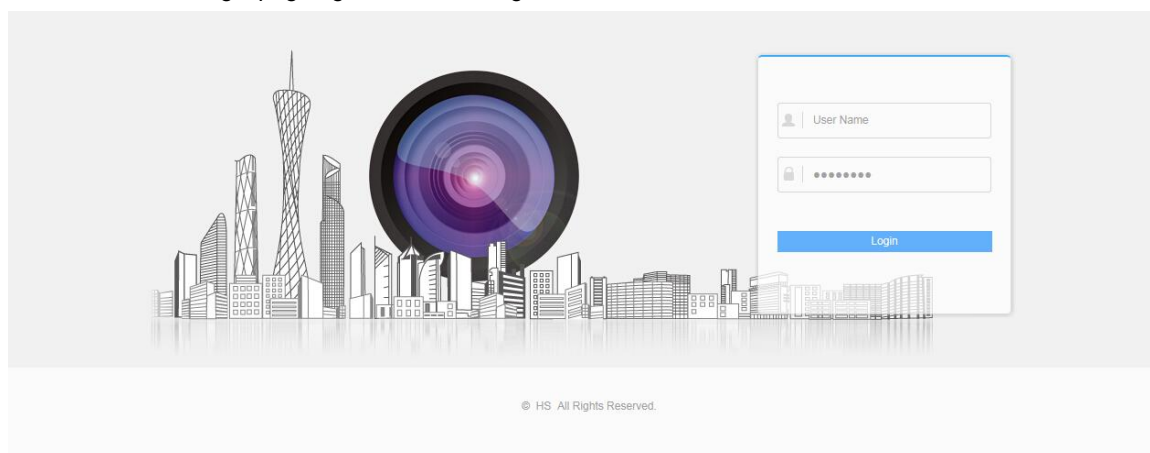

Note: If the system prompt "installation failure", please uncheck the "cancel protection mode" in the setting safety of "Internet options" and enter the "custom level" ActiveX control Settings as shown below, and reinstall HsWebplugin.exe after save settings.

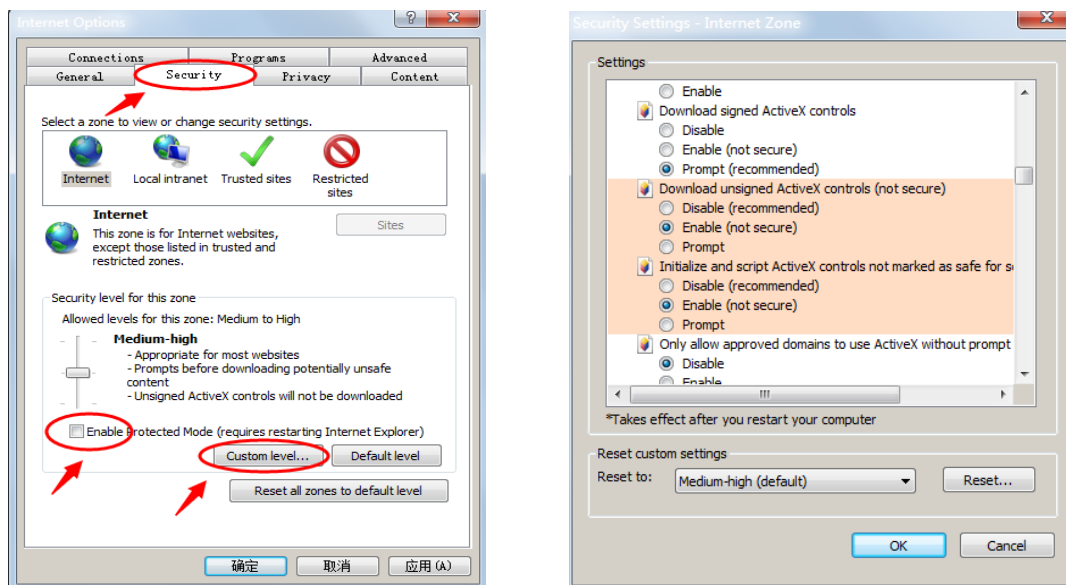

4.3. Interface operations and Usage:

4.3.1. Login

Login for the first time must input account: " admin " and password: " admin " on the login interface as below.

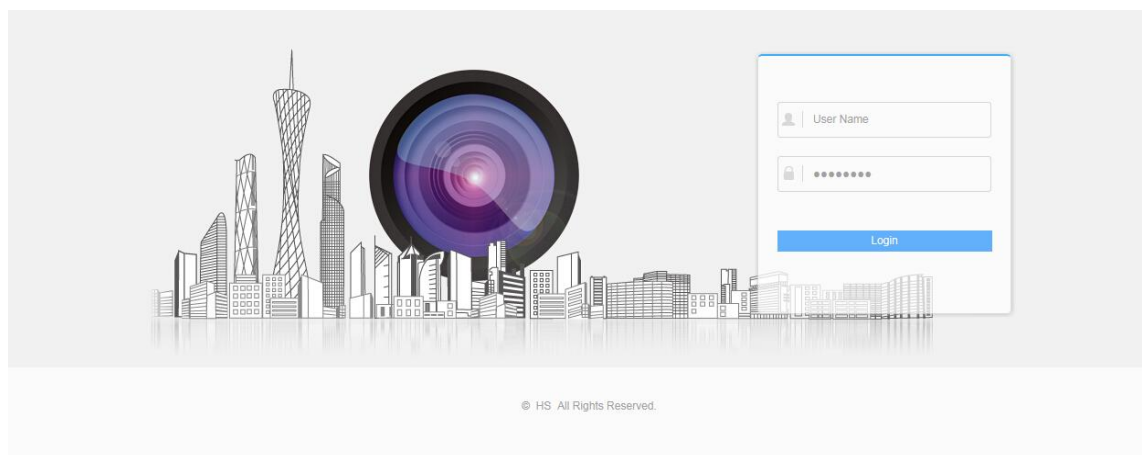

4.3.2. Live preview

4.3.2.1. Live View Page

Login the network camera to enter the live view page, or you can click Live View on the menu bar of the main page to enter the live view page. The live view page allows you to view the real-time video, capture images, realize PTZ control, set/call presets and configure video parameters.

Descriptions of the live view page:

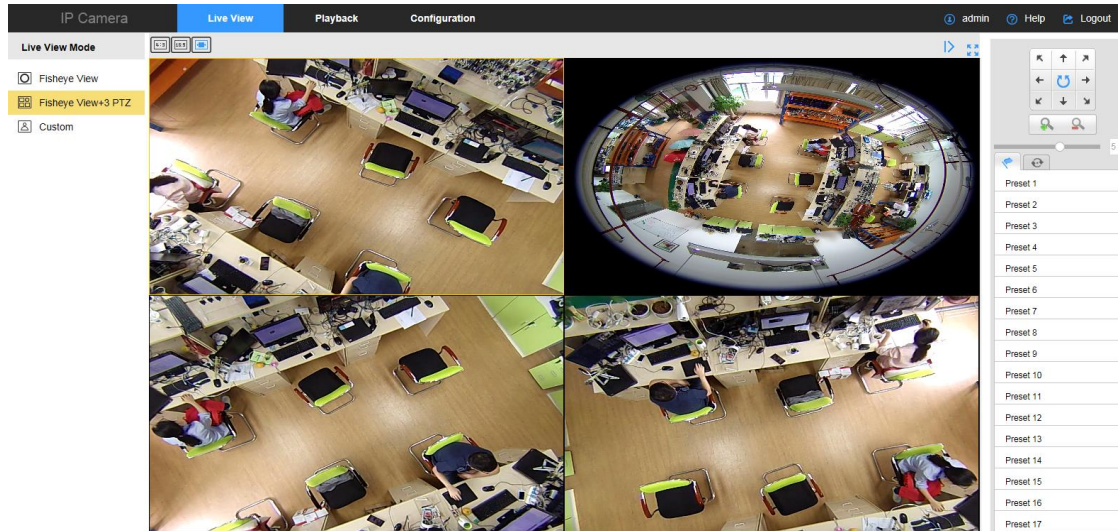

【Menu Bar】 Click the tab to enter Live View, Playback and Configuration page respectively.

【Layout Control】 Click each tab to adjust the layout of the live view. 4:3, 16:9, and auto are selectable.

【Live View Mode】 Display the live video in Fisheye View, Panorama View, or PTZ View.

【Fisheye View】 In the Fisheye View mode, the whole wide-angle view of the fisheye camera is displayed. This view mode is called Fisheye View because it approximates the vision of a fish’s convex eye. The lens produces curvilinear images of a large area, while distorting the perspective and angles of objects in the image.

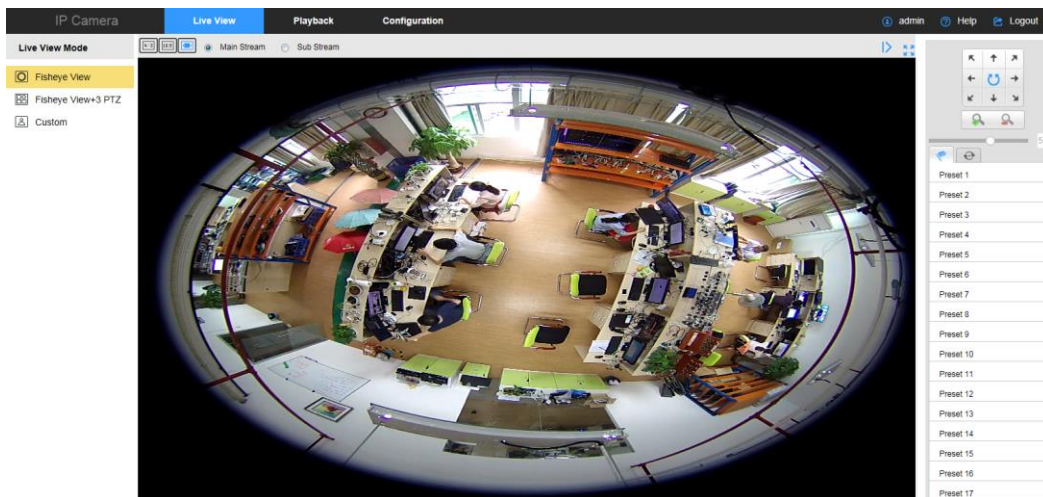

【Panorama View】 In the Panorama View mode, the distorted fisheye image is transformed to normal perspective image by some calibration methods.

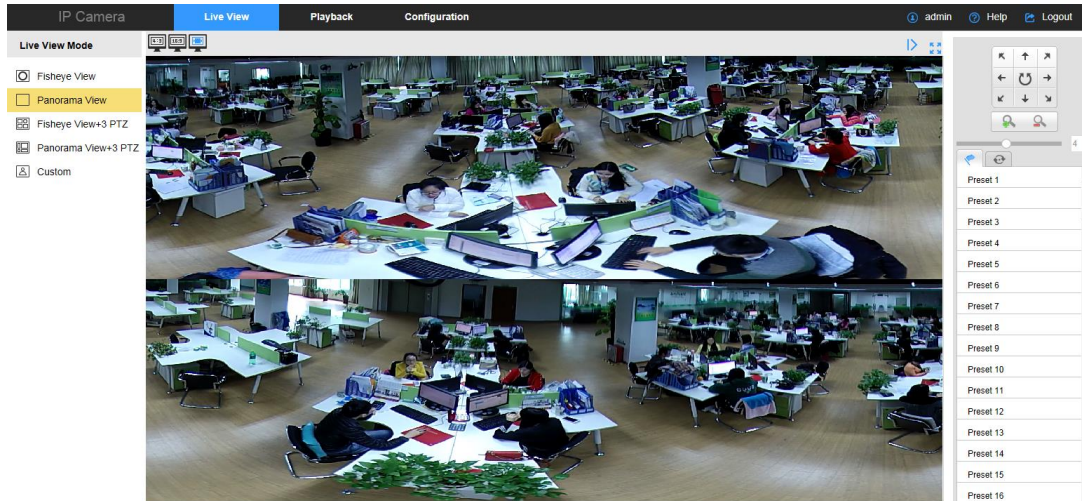

【PTZ View】 The PTZ View is the close-up view of some defined area in the Fisheye View or Panorama View, and it supports the electronic PTZ function, which is also called-PTZ.

Note: Each PTZ View is marked on the Fisheye View.

【Live View Window】 Display the live view in fisheye mode, panorama mode, or PTZ mode.

【Toolbar】 Start / Stop the live view, enable / disable the two-way audio, capture pictures and record the video files.







【PTZ Control】 Realize the pan / tilt / zoom function of PTZ view via the navigation box, and set the PTZ moving speed.



【Preset/Cruise Settings】 Set and call the preset/cruise for the camera.

4.3.2.2. Starting Live View



In the live view window as follow [Figure](#), click  on the toolbar to start the live view of the camera.



Icon	Description
	Start/Stop live view.
	The window size is 4:3.
	The window size is 16:9.
	Self-adaptive window size.
	Manually capture the picture.
	Manually start/stop recording.

 / 	Open/close talk back
<input checked="" type="checkbox"/> Open Sound Off / <input type="checkbox"/> Open Sound Off	Turn on/off Sound.

4.3.2.3. Recording and Capturing Pictures Manually

In the live view interface, click  on the toolbar to capture the live pictures or click  to record the live view. The saving paths of the captured pictures and clips can be set on the Configuration > Local Configuration page.



Note: The captured image will be saved as JPEG file in your computer.

4.3.3. Operating PTZ Control

Purpose:

In the live view interface, you can use the PTZ control buttons to realize pan/tilt/zoom control of the camera.

If the expand mode is 1 fisheye + 3 PTZ or 1 panorama + 3 PTZ, you can use the PTZ control interface to adjust the view angle and the PTZ speed.

On the live view page, click  to show the PTZ control panel or click  to hide it.



Click the direction buttons to control the pan/tilt movements.



Figure 4-5(1) PTZ Control Panel

Note:

There are 8 direction arrows () in the live view window when you click in the relative positions.

Icon	Description
	Auto Scan
	Zoom in/out
	Adjust speed of pan/tilt movements

4.3.4. Setting / Calling a Preset

4.3.4.1. Setting a Preset:

(1) In the PTZ control panel, select a preset number from the preset list.



(2) Use the PTZ control buttons to move the lens to the desired position.

Pan the camera to the right or left.

Tilt the camera up or down.

Zoom in or out.

(3) Click  to finish the setting of the current preset.

(4) You can click  to delete the preset.

Note: You can configure up to 128 presets.

4.3.4.2. Calling a Preset

This feature enables the camera to point to a specified preset scene manually when an event takes place. For the defined preset, you can call it at any time to the desired preset scene. In the PTZ control panel,

select a defined preset from the list and click  to call the preset.

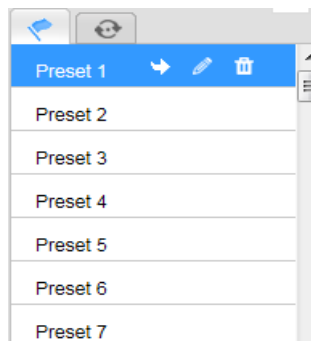



4.3.5 Setting / Calling a Cruise

Note:



No less than 2 presets have to be configured before you set a cruise.

Steps:

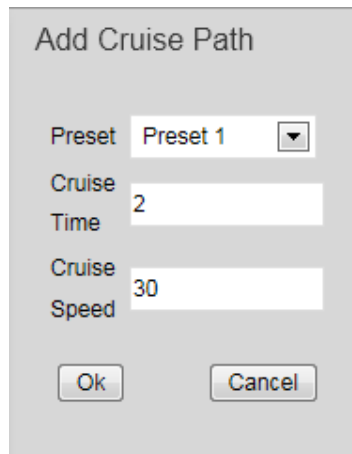
- (1) Click  to enter the cruise configuration interface.
- (2) Select a path No., and click  to add the configured presets.
- (3) Select the preset, and input the cruise duration and cruise speed.
- (4) Click OK to save the first preset.
- (5) Follow the steps above to add the other presets.



(6) Click  to save a cruise.

(7) Click  to start the cruise, and click  to stop it.

(8) (Optional) Click  to delete a cruise.

4.4. Network Camera Configuration

4.4.1. Local Configuration

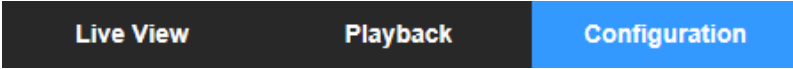
Click  into the parameter configuration screen, where you can manually set the storage path for your record video & picture files, log export files as well as capture files. As shown below:

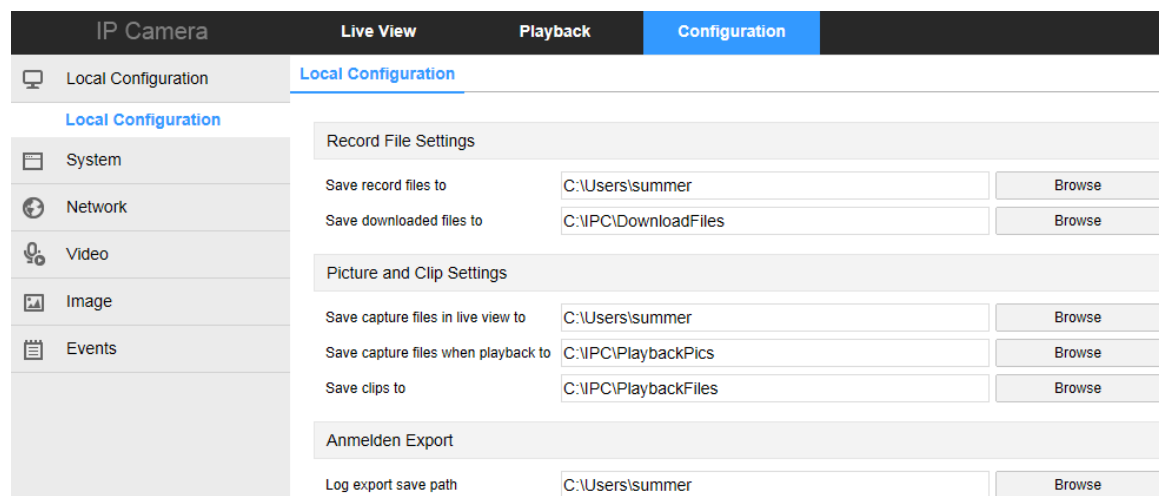

【Record File Settings】 Set the saving path of the recorded video files. Valid for the record files you

recorded with the web browser.

【Save record files to】 Set the saving path for the manually recorded video files.

【Save downloaded files to】 Set the saving path for the downloaded video files in playback mode.

【Picture and Clip Settings】Set the saving paths of the captured pictures and clipped video files. Valid for the pictures you captured with the web browser.

【Save capture files in live view to】 Set the saving path of the manually captured pictures in live view mode.

【Save capture files when playback to】 Set the saving path of the captured pictures in playback mode.

【Save clips to】 Set the saving path of the clipped video files in playback mode.

【Anmelden Export】 Set the saving paths of the exported log

【Log export save path】 Set the saving path of the exported log

Note: You can click **Browse** to change the directory for saving the clips and pictures.

4.4.2. System

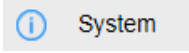
Click  into the system configuration interface.

4.4.2.1. System Configuration

① Device Information

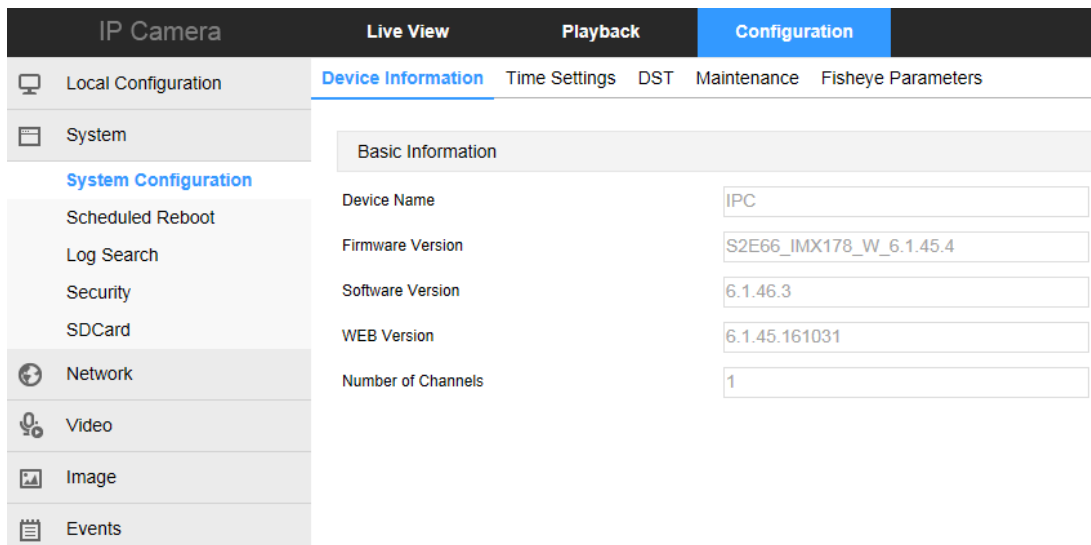

Here you can see the basic information of the current device.

【Device Name】 The name of the current IPC.

【Firmware Version】 The current version of the IPC.

【Software Version】 The current HsWebplugin.exe control version of the IPC.

【WEB Version】 The current page version of the IPC.

【Number of Channels】 The current channels of the IPC, the default is 1.

② Time Setting

Click “Time Setting” into the set the time interface.

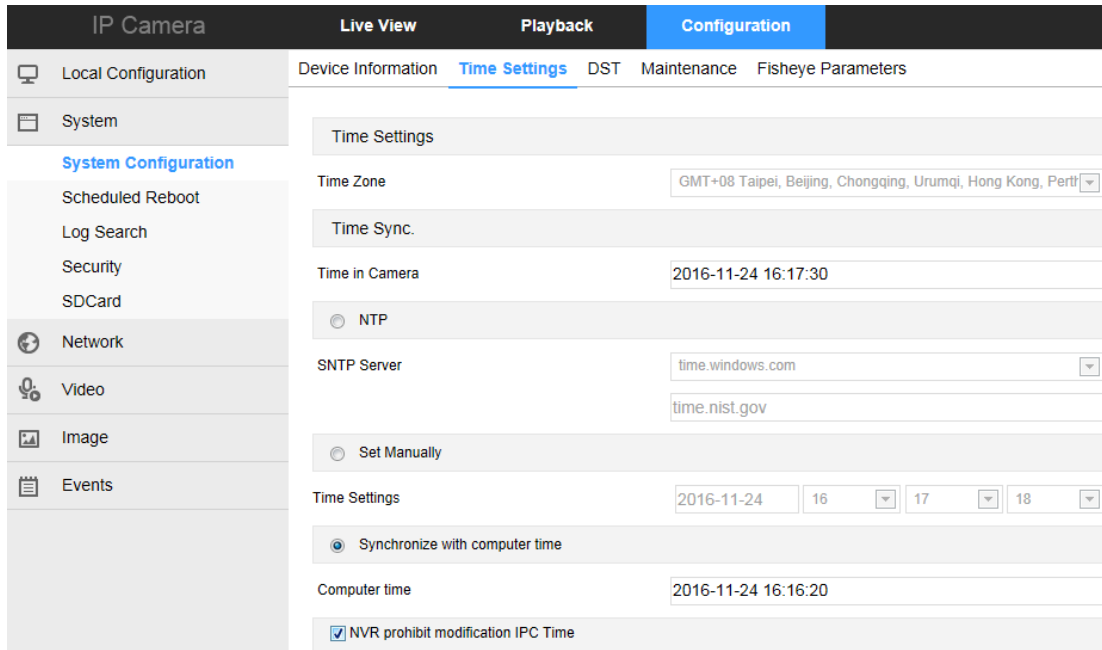

【NTP】 The IPC time will synchronization with network, and you can change the different time zones. (This feature requires that IPC network environment can connect to the Internet.) Click on the "Save" after completing the settings.

【Set Manually】 Setting the IPC 's date and time manually. Click on the "Save" after completing the settings.

【Synchronize with computer time】 The IPC will synchronize with the computer time and date that your connect currently. Click on the "Save" after completing the settings.

【NVR prohibit modification IPC time】 The IPC time will be not affected by the backend storage devices (such as NVR and XVR, etc.) after check this option. The IPC 's time will be running according to the user settings.

③ DST

Click “DST” into the daylight saving time setting interface.

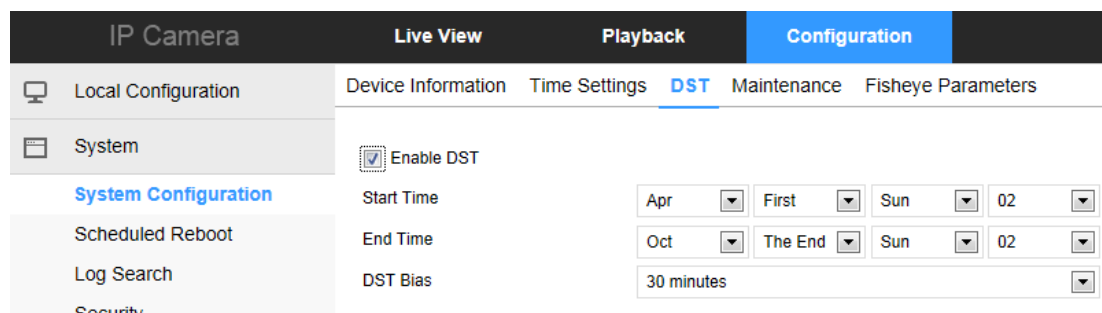

To enable daylight saving time here, set the start time, end time, and offset time for Daylight Saving Time.

④ Maintenance

Click "Maintenance" into the setup interface.

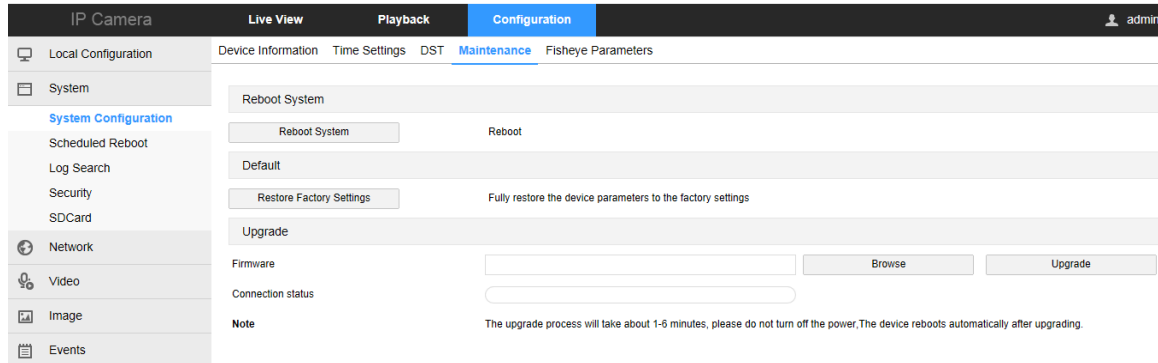

【Reboot System】 The IPC will restart again automatically after clicking "Reboot System".

【Restore Factory Settings】 The IPC will restore to factory default parameters automatically after clicking this option. (Camera IP and other network parameters will not be restored to the factory, other settings will be restored to factory defaults. Please operate this function carefully).

【Firmware】 Clicking to add upgrade file package, and upgrading the IPC program. (Please careful operation, the error of upgrade file will cause equipment system operate abnormally).

⑤ Fisheye Parameters

Click "Fisheye Parameters" into the fisheye parameter setting interface.

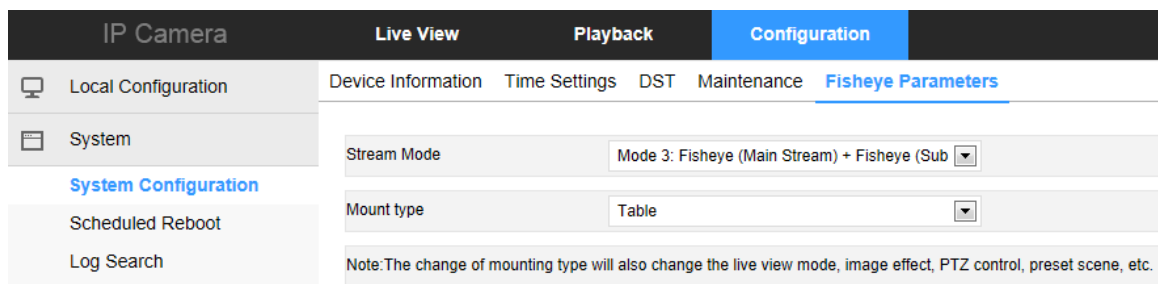

Here you can set stream mode and mount type, select stream mode different camera output corresponding to the different stream; The installation method is selected according to the actual installation position of the camera.

4.4.2.2. Scheduled Reboot

Click [Scheduled Reboot](#) into the scheduled reboot interface.

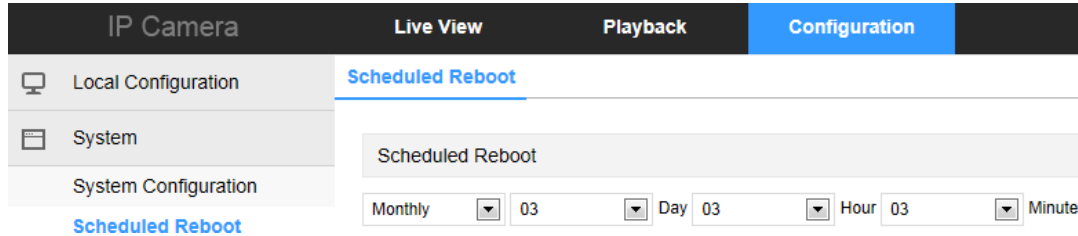

It can be set "cycle" and "time" from the pull down menu, such as setting "every day to restart in 1:00 am", click to save. The IPC will restart every day after 24 hours at 1 AM.

4.4.2.3. Log Search

Click [Log Search](#) into the log search interface.

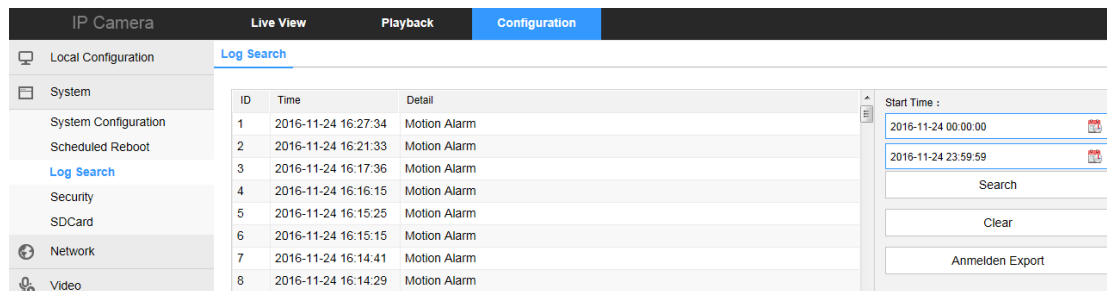

【Search】 It can find running record of IPC from the start time to end time.

【Clear】 Clicking clear button to empty all logs.

【Anmelden Export】 Save the contents of the current log to the location you specified in txt format.

4.4.2.4. Security

Click [Security](#) into the user management interface.

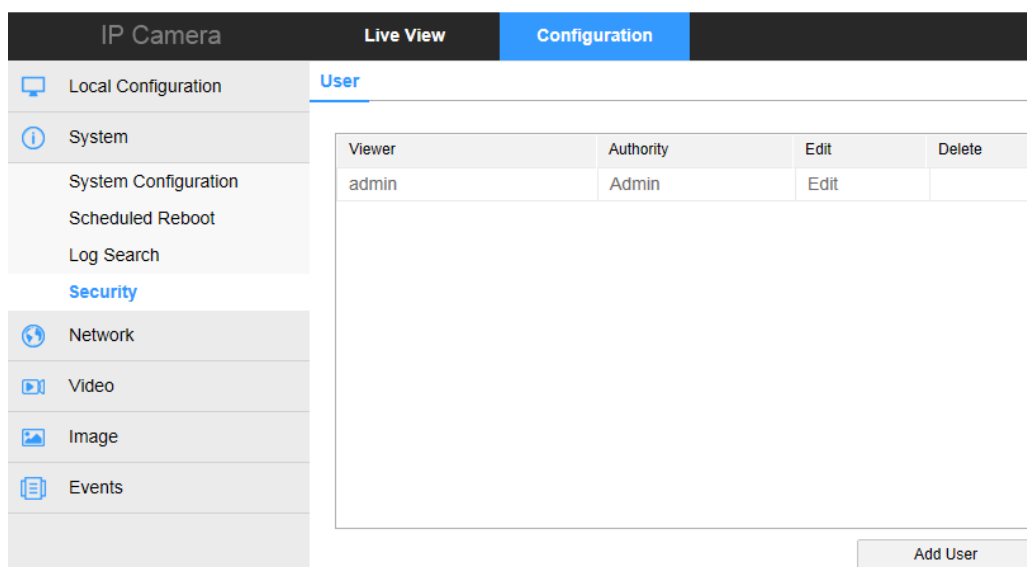

Here you can click “Edit” to modify the original account password, and click“ Add User ”to create / delete an administrator account, create / delete operator account, or create / delete user account, a total of 10 accounts can be created. The system administrator account is prohibited to delete.

4.4.2.5. SD Card

Click **SDCard** into the SD card management interface.

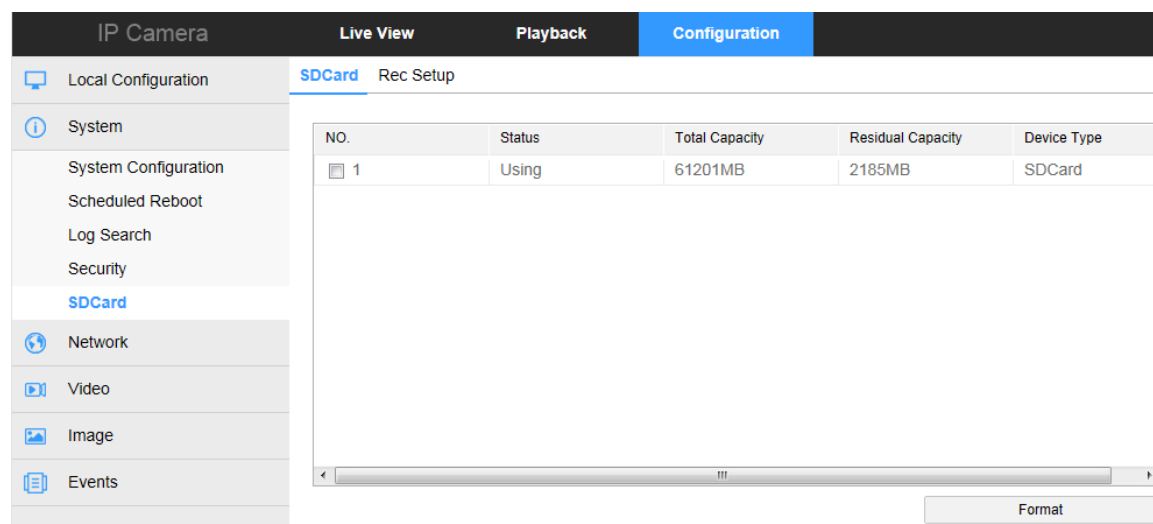

Here you can view the SD card detected in the camera, and SD card format.

Click “Rec Setup” into the recording setting interface.

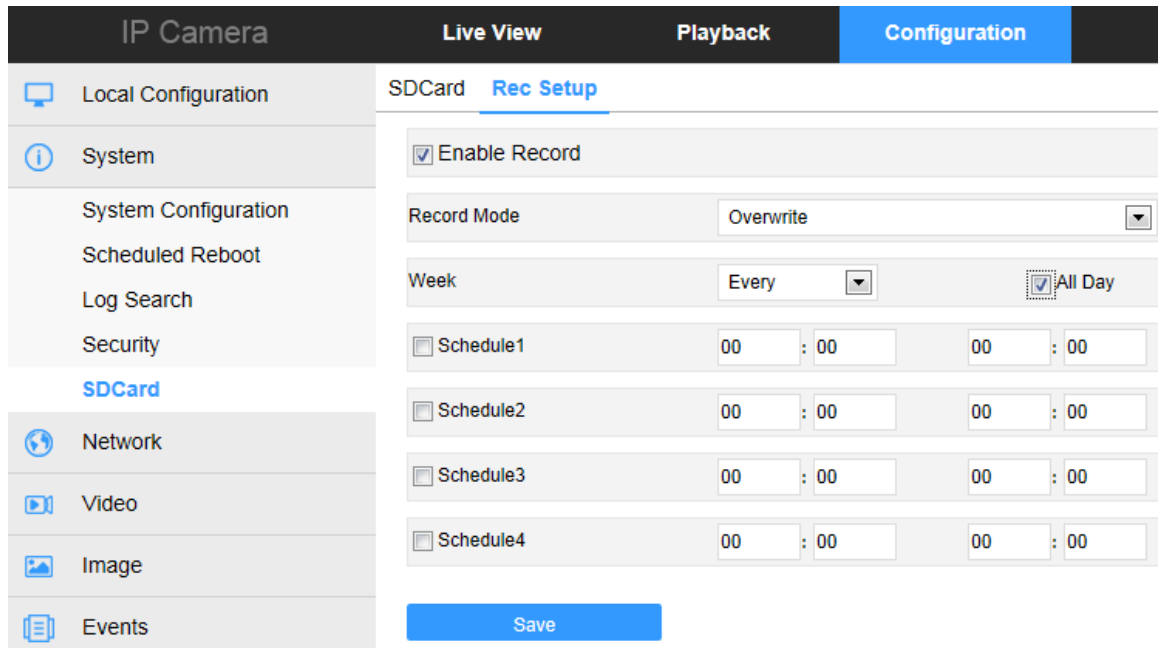

Here you can open the SD card video, set the SD card recording schedule and recording mode.
 Note: The camera without the function of SD card video recording will not display the SD card management interface, please take the camera physical specific functions shall prevail.

4.4.3. Network

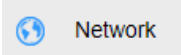
Click  into the network setting interface.

4.4.3.1. Basic Setup

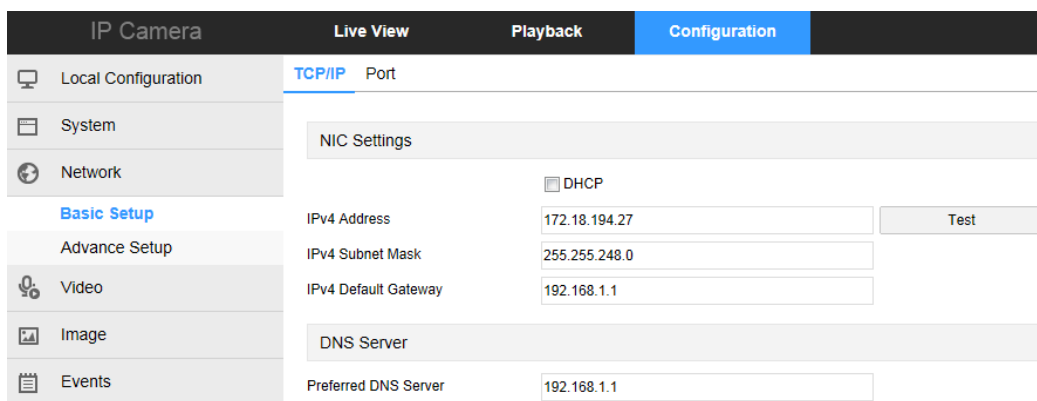

① TCP/IP

The IPC is connected to the router that have opened the DHCP function, check the DHCP option, and the IPC can be get automatically IP address、Net mask、Default Gateway and DNS。
 Don't check the DHCP, you can manually modify the IP address、Net mask、Default Gateway and DNS for IPC.

② Port

Click "port" into the port settings interface, can manually modify the IPC's HTTP, RTSP and other port numbers.

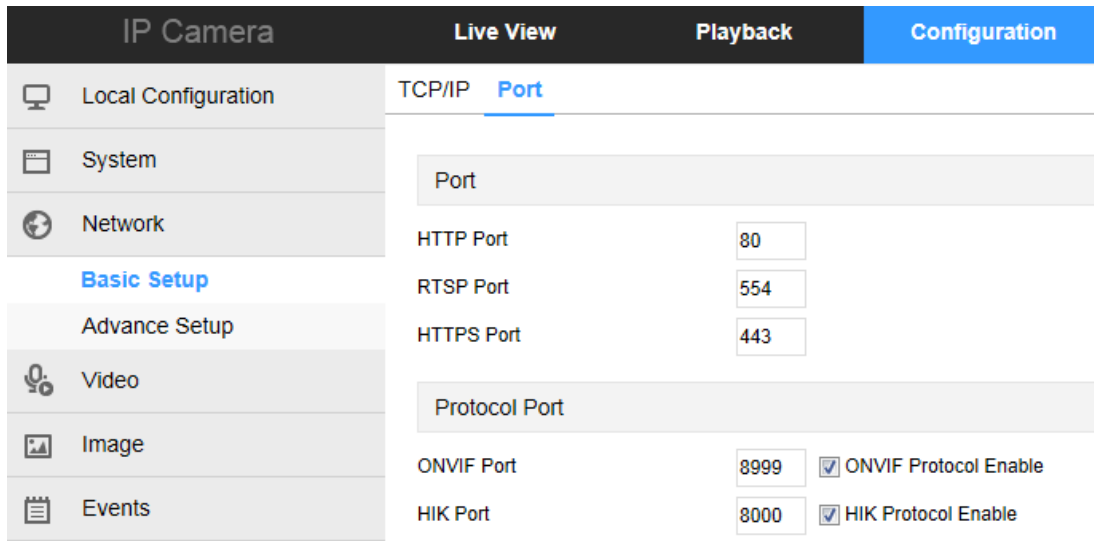

4.4.3.2. Advance Setup

Click [Advance Setup](#) into the advance network setting interface.

① DDNS

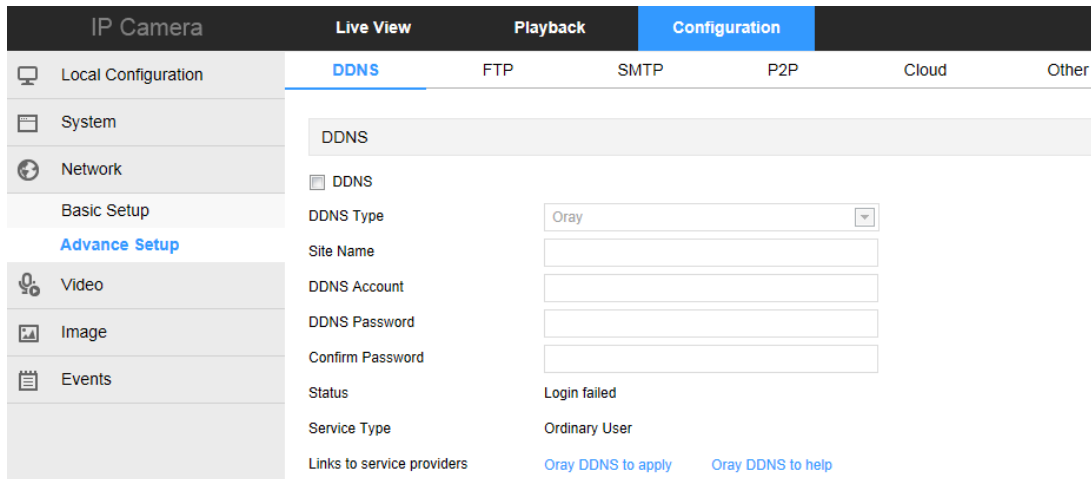

Open the DDNS (Dynamic Domain Name Server), click the link to register DDNS service account. Fill in the account name and password that you registered. Then you can access your IPC through DDNS. (Note: IPC must be connected to the Internet).

② FTP

Click "FTP" into the FTP setting interface.

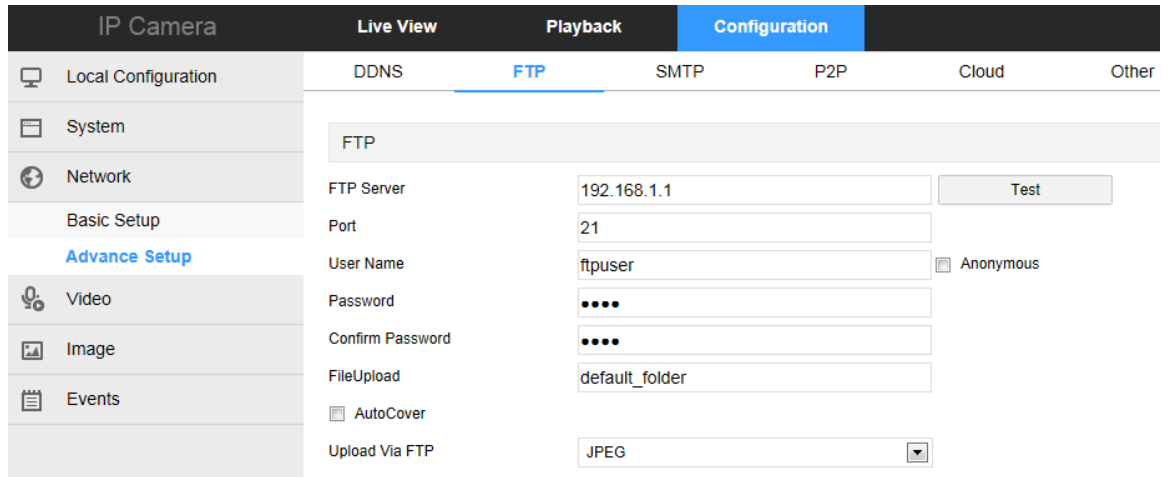

【FTP Server】 Fill in the FTP server address.

【Port】 Fill in the FTP server port number.

【User Name】 Fill in the FTP server username.

【Password】 Fill in the FTP server password.

【Confirm Password】 Fill in the FTP server password.

【File Upload】 Automatically creates a folder that you named in the FTP storage path.

【Auto Cover】 When enabled, the oldest FTP server will be overwritten automatically when the FTP server is full.

【Upload Via FTP】 In the drop-down menu, select FTP file format, JPEG image format and AVI video for selection. Click on the "Save" after completing the settings.

③ SMTP

Click "SMTP" into the SMTP setting interface.

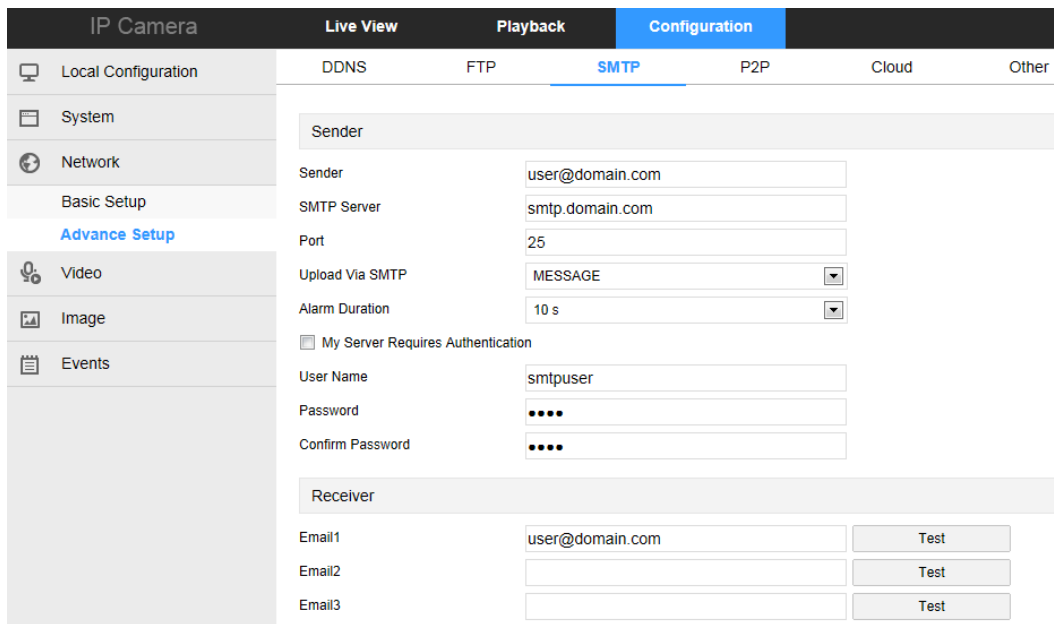

Sender

【Sender】 Fill out the full address of the sender mailbox.

【SMTP Server】 Fill in your email server address.

【Port】 Fill in your email server port.

【Upload Via SMTP】In the drop-down menu, select SMTP file format, JPEG image format, AVI video and message for selection. Click on the "Save" after completing the settings.

【Alarm Duration】 Set the sending interval.

【My Server Requires Authentication】 When enabled, the server and user are authenticated to ensure that the data is sent to the correct client and server.

【User Name】 Fill out the send mailbox user name.

【Password】 Fill out the send mailbox password.

【Confirm Password】 Fill out the send mailbox password.

Receiver

【Email】 Fill in the full address of your inbox, here up to 3 inboxes, click on the completion of the completion of the "test" to ensure that all the correctness of the input information and network connectivity of the camera.

④ P2P

Click“P2P”into P2P configuration interface.

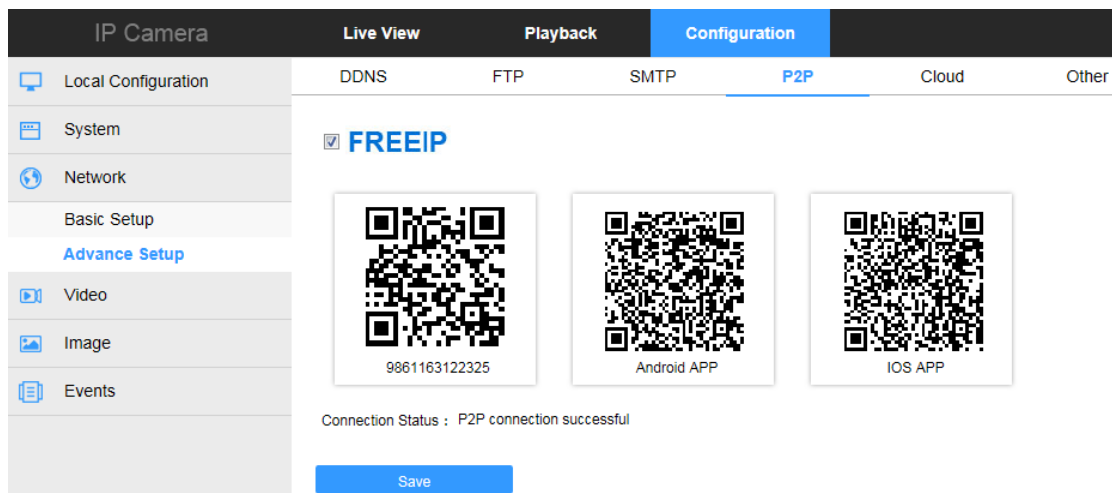

This function is mainly used mobile client for remote monitoring. Currently, the FreeIP PRO client we offer has Android version and iOS version. Users can be added to the appropriate mobile client by scanning the QR code. (Remote monitoring requirements IPC connected to the Internet).

⑤ Cloud

Click “Cloud” into the cloud setting interface.

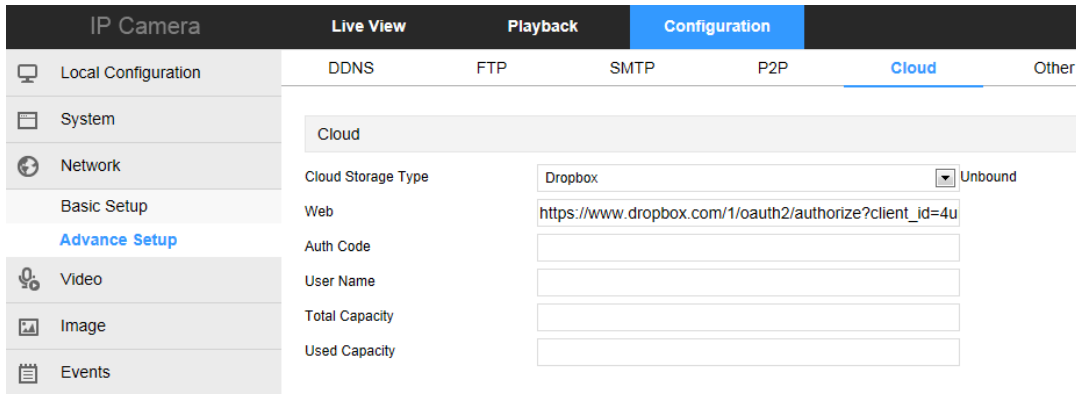

【Cloud Storage Type】 Select the cloud storage type, Dropbox or Google in the drop-down menu.

【Web】 Depending on the type of cloud storage selection play a cloud url, login web site registered account according to clew clouds.

【Auth Code】 Login cloud web, the verification code will display on the cloud storage interface, than copy it in the space.

Fill in the verification code, click on the "Bind" after the success. "User name", "Total Capacity" and "Used Capacity" that information will be automatically displayed.

⑥ Other

Click "Other" into the video and audio setting interface.

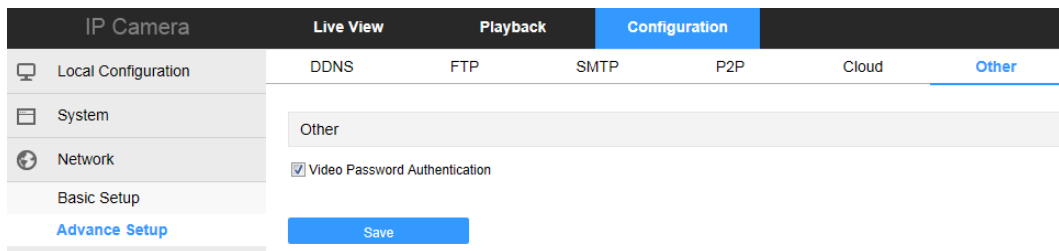

Here, the video password authentication is enabled. All the devices connected to the camera through the ONVIF protocol must be connected to the camera.

⑦ Wifi

Click "Wifi" into the video and audio setting interface.

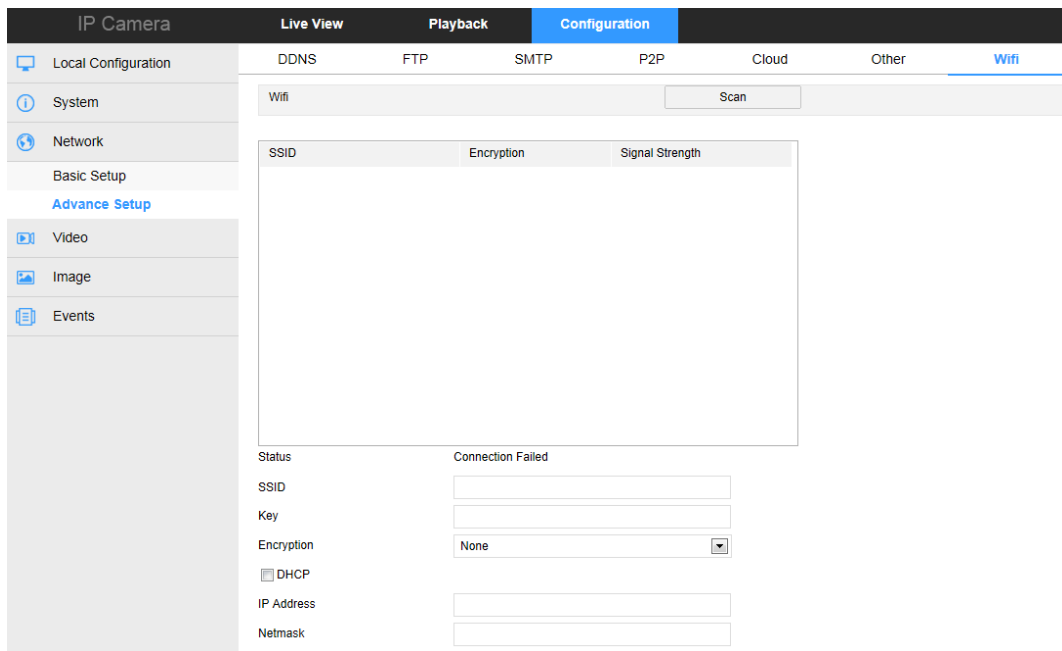

Here you can configure the camera to connect the WiFi to the camera, click Scan to search for a nearby WiFi connection, select the camera you want to connect to WiFi, enter the WiFi password, turn DHCP on or not, and click Save.

Note: Normal camera no“Wifi” setting interface, please take the camera physical specific functions shall prevail.

4.4.4. Video

Click  Video into the video and audio setting interface.

4.4.4.1. Video

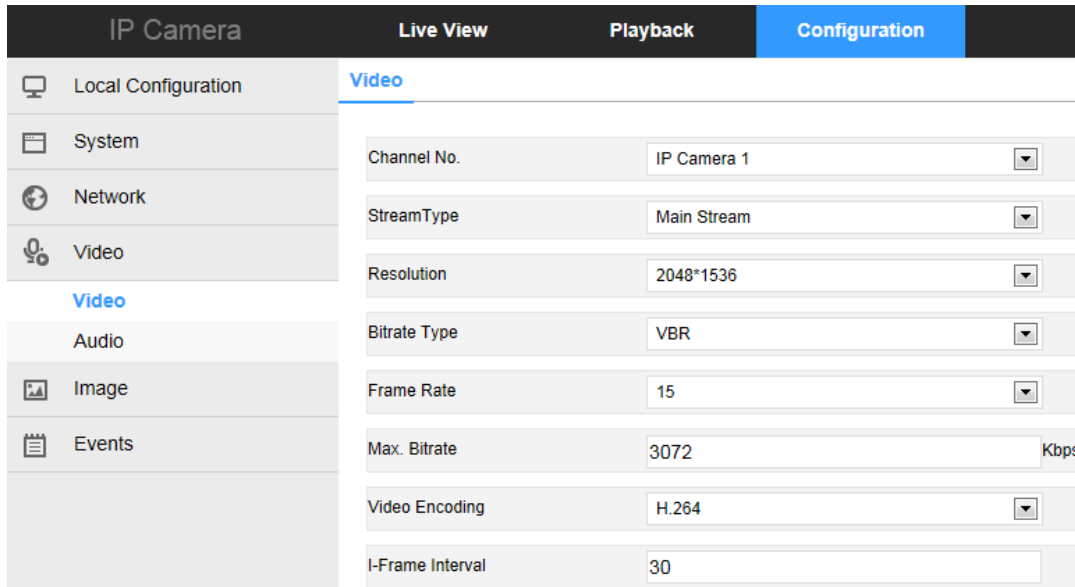

【Channel NO.】 You can customize the following parameters for the selected Channel No.

【Stream Type】 Select the bitrate type to single or second.

【Resolution】 Select the video output resolution of the current channel.

【Bitrate Type】 Switch the code rate output mode in the drop-down menu, fixed rate and variable rate.

【Frame Rate】 Set the frame rate of the current output video of the device. (Note: Frame rate is too low will cause the video caton)

【Max. Bitrate】 Support 32-16384kbps. The higher the bit rates the better video quality, but it occupy the greater network bandwidth and the greater the pressure transmission.

【Video Encoding】 Select the bitrate type to H.264 or H.265.

【I Frame Interval】 IPC acquisition key frame interval, can be set 1-300s.

Note: The supported video encoding may be different according to the different platform.

4.4.4.2、Audio

Click **Audio** into the audio configuration interface.

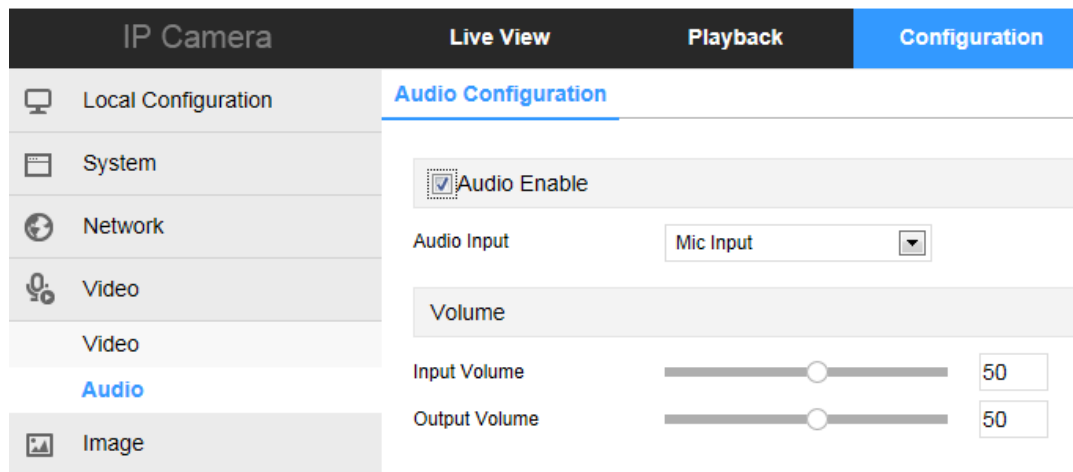

Open the audio, pull bar to set the input volume (range 0-100 range optional). Click “Save” to complete the setting.

4.4.5. Image

Click  Image into the image configuration interface.

4.4.5.1. Image

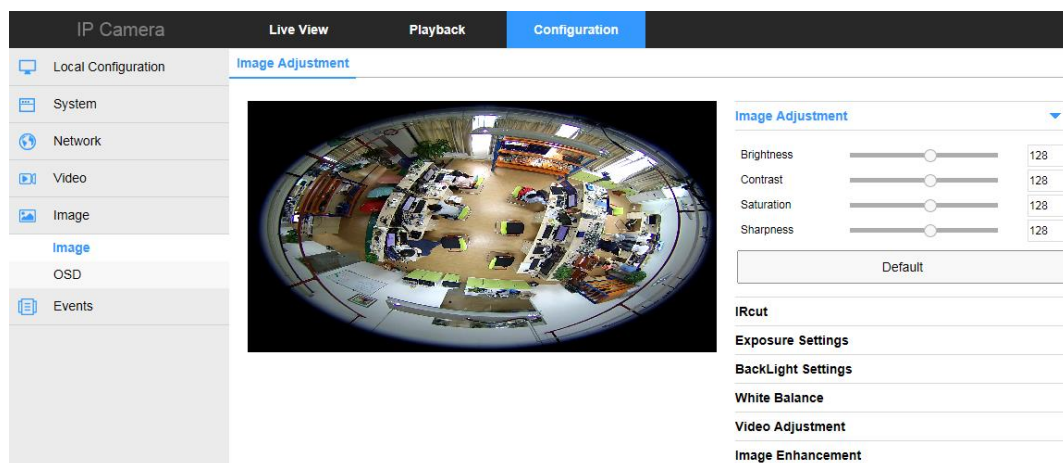

【 Brightness/Contrast/Saturation/Sharpness 】 You can input the value manually to set brightness, contrast, saturation, sharpness. These parameters shall be set according to the actual environment. The scope of valid values is from 0 to 255, you can drag the slider to set, and the default value is 128.

Image Adjustment ▼

Brightness 128

Contrast 128

Saturation 128

Sharpness 128

Default

【IRcut】 Select the day/night switch mode, and configure the IR switching time from this option.

IRcut ▼

Ircut Filter Time ▼

Ircut Mode ▼

【Exposure Settings】 It have automatic mode and manual mode, the manual mode when the click, "Gain Control" is active, valid values are (0-255) and the default value is 128. At the same time can set the speed of the electronic shutter. Click "Save" to complete the setting.

Exposure Settings ▼

Exposure Settings Auto Manual

Exposure Time ▼

Gain Control 0

【White Balance】 It have automatic mode and manual mode, the manual mode when the click, "Red gain" and "green gain", "Blue Gain" is active, valid values are (0-255) and the default value is 128. Click "Save" to complete the setting.

White Balance ▼

White Balance ▼

Red Gain 0

Green Gain 0

Blue Gain 0

【Image Enhancement】 It have flicker control and sensor linear WDR setting.

- **Flicker Control:** Indoor PAL, Indoor NTSC and outdoor are selectable. The flash mode is selected according to the camera installation environment and the flicker standard; normally 50 Hz for PAL standard and 60 Hz for NTSC Standard.

- **WDR:** Wide Dynamic Range can be used when there is a high contrast of the bright area and the

dark area of the scene.



4.4.5.2. OSD

Click **OSD** into the overlay setting interface.

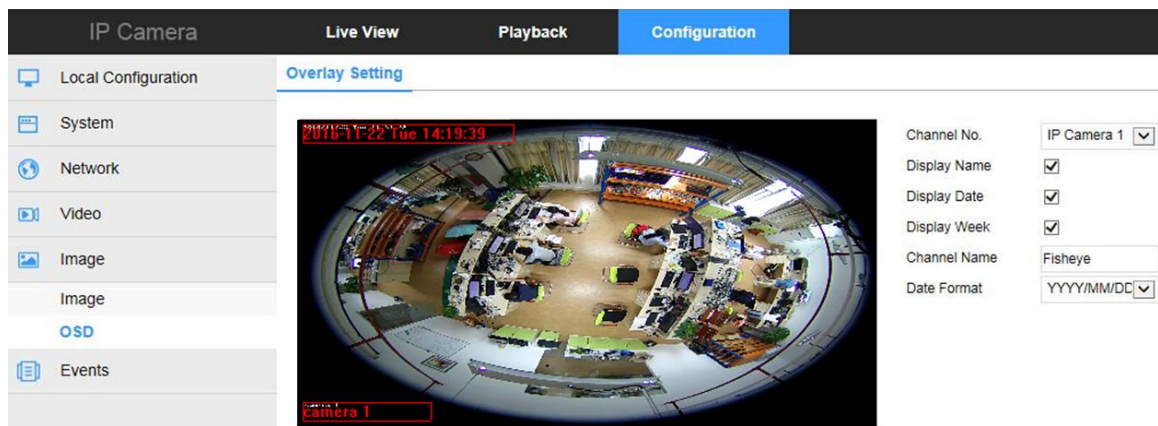

It allows you to select the channel NO. and set the appropriate name, date, weekday and date formats, OSD position, and display in the corresponding channel preview screen.

4.4.6. Events

4.4.6.1. Motion Detection

Click **Events** into the motion detection setting interface.

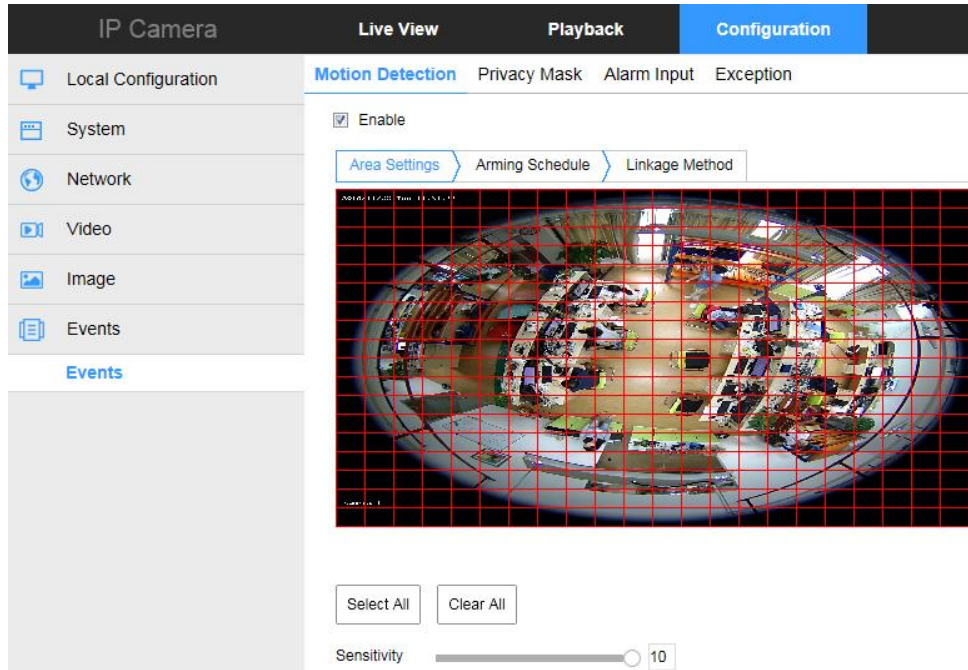

【Select All】 Motion detection range to monitor all of the area, which Consists of 396(22*18) small squares. Of course you can choose a combination of several small squares among them as motion detecting area.

【Clear All】 Clearing all the motion detecting area that selected currently.

【Sensitivity】 Can be selected 0 to 10, and the higher the value, the greater the sensitivity.

Click “Arming Schedule” into the arming time setting interface.

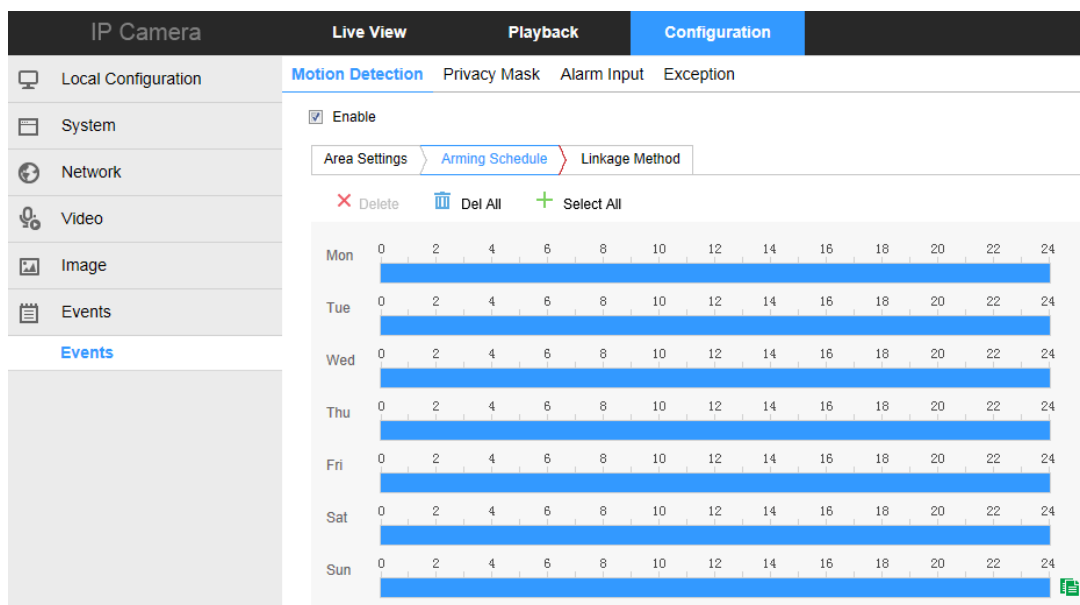

Here, set the motion detection alarm period, add, delete, edit.

(1) Choose the day you want to set the arming schedule.

- (2) Click and drag the mouse on the time axis to edit the arming schedule.
- (3) Click Save to save the settings.

Click “Linkage Method” into the linkage mode setting interface.

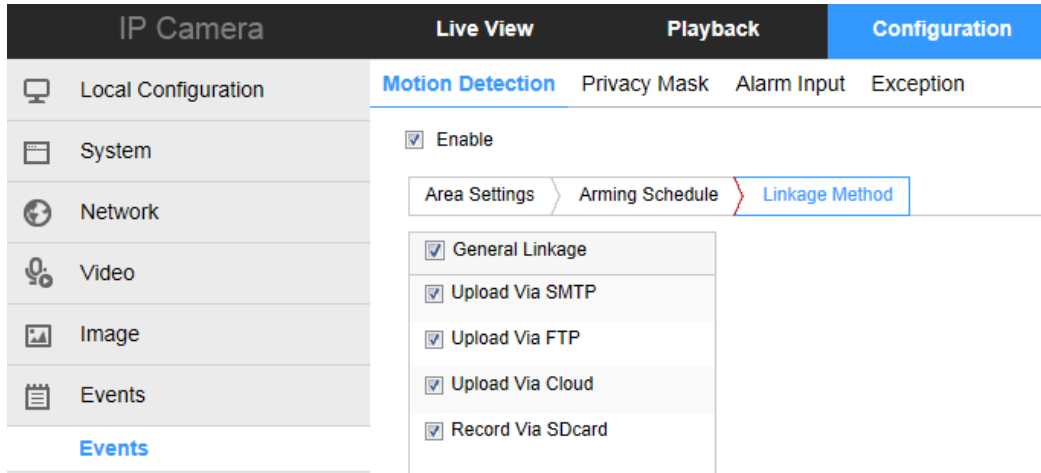

Open the "General linkage", "upload Via SMTP", "upload Via FTP", "upload Via Cloud" function, when the device motion detection alarm, the linkage corresponding way to inform the user.

4.4.6.2. Privacy Mask

Click “Privacy Mask” into the privacy setting interface.

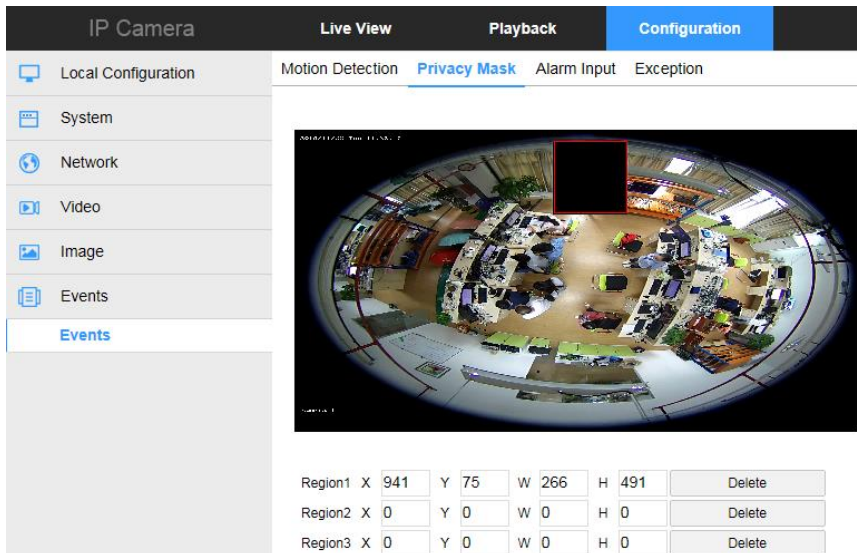

Pressing the left mouse button and drag to select area in the region. Region 1、Region 2、Region 3 bellow will show the corresponding coordinates, width, and height of the region .If you want to delete a region, click on the corresponding “Delete” button. Click on the “Save” after completing the setting.

4.4.6.3. Alarm input

Click “Alarm input” into the alarm input interface.

- **Alarm schedule**

Click “Arming Schedule” into the linkage alarm time setting interface.

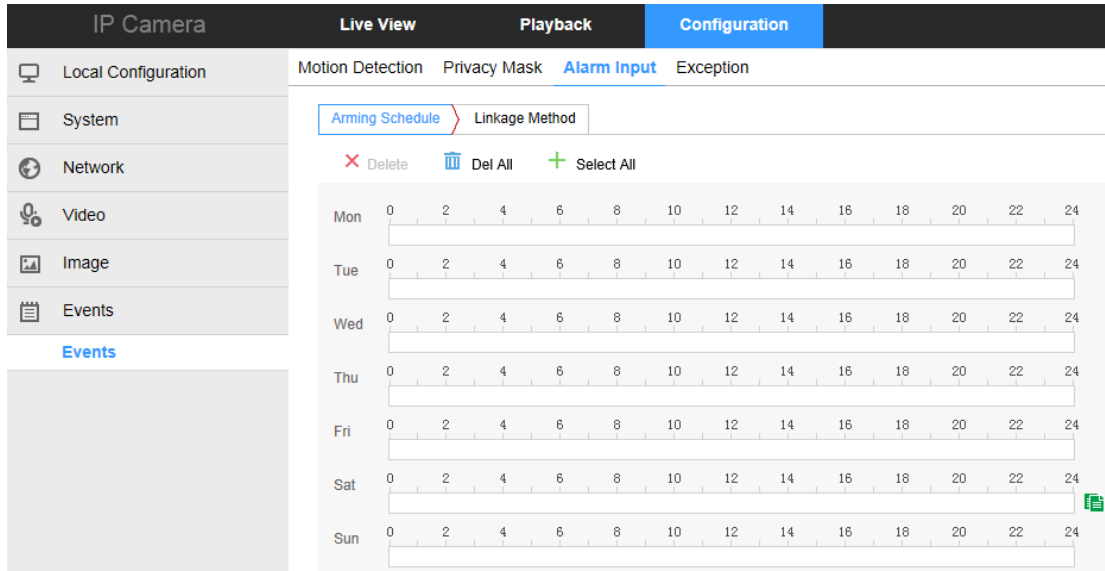

Set the time period for linkage alarm, add, delete, edit. Click on the “Save” after completing.

Click “Linkage Method” into the linkage mode setting interface

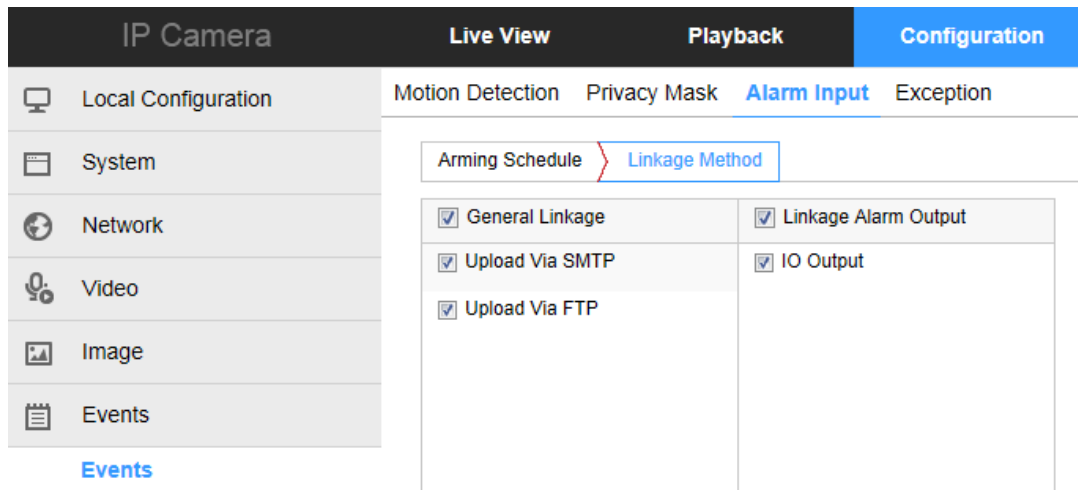

Open the "General linkage", "upload Via SMTP", "upload Via FTP" function, when the device occlusion alarm, the linkage corresponding way to inform the user.

4.4.6.4 Exception

Click “Exception” into the abnormal alarm setting interface.

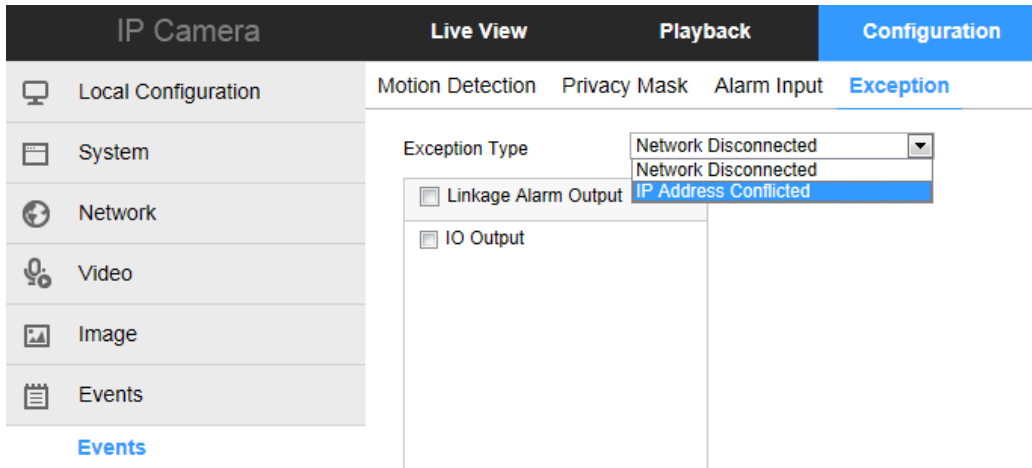

Set the "Cable Disconnection" and "IP Address Conflict" alarms here, and set the alarm output mode. Click on the "Save" after completing the settings.

4.5. Playback

In the main interface, click [Playback](#) enter palyback interface.

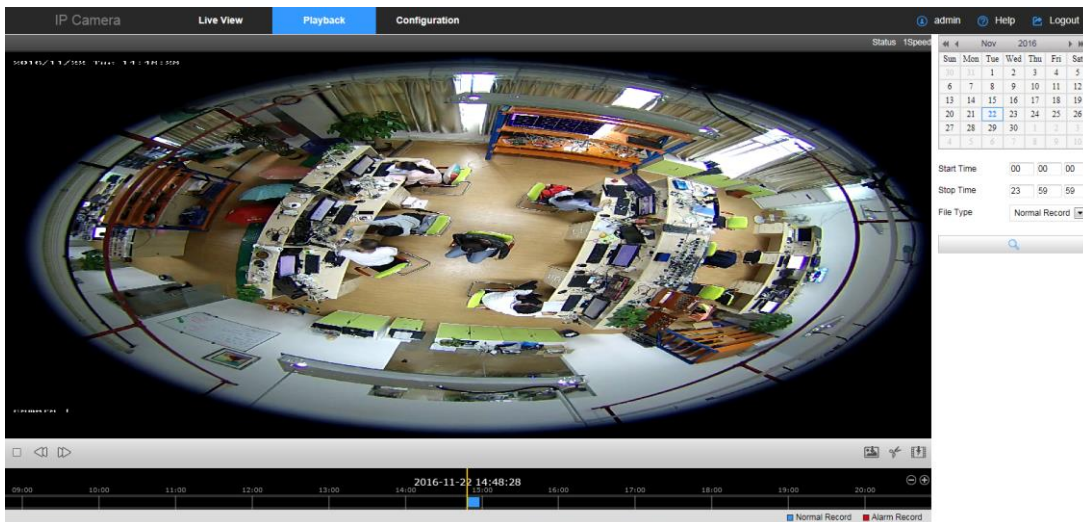

Here you can query the video files in the SD card according to the recording type (Normal Record, Alarm Record) and recording time, playback, screenshot, clip and download to the video file.





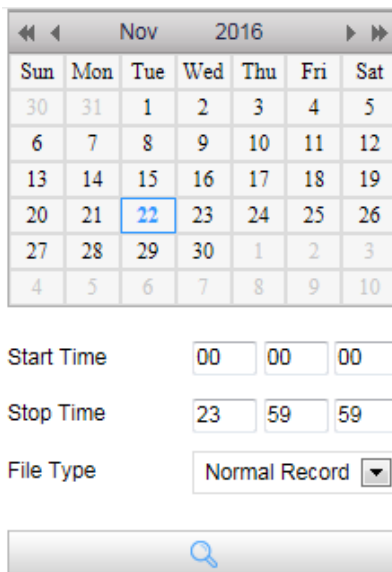



Steps:

- (1) Select the date to set the Start Time and Stop Time.
- (2) Select the File type Normal or Alarm Record in the drop-down list.
- (3) Click Search.



(4) Click  to play the video files found on this date.

Description of the buttons as below

Button	Operation	Button	Operation
	Play		Capture a picture
	Pause		Start/Stop clipping video files
	Speed down		Download video files
	Speed up		Download captured pictures

Note: You can drag the progress bar with the mouse to locate the exact playback point. You can also click  to zoom out/in the progress bar.



The toolbar on the bottom of Playback interface can be used to perform various operations on the recorded video.



The different colors of the video on the progress bar stand for the different video types.

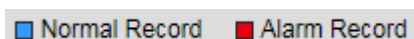

Note: No SD card storage video camera and no video playback settings interface, please take the

camera physical specific functions shall prevail.

5. App client

5.1. Download and install App

Download and install FreeIP on your smart phone. Please scan the following QR codes to download the App, or you can download from the following websites:

Android App: <https://play.google.com/store/apps/details?id=com.xc.hdscreen>

iOS App : <https://itunes.apple.com/cn/app/freeip/id898690336?mt=8>



Android APP



iOS APP

5.2. Add device

Add a device to the device list to manage.

Steps:

(1) Open the FreeIP you install on the smart phone (New users please register an account), and log in the account.



(2) Enter the sliding menu, Click **【Device】** to add the device.

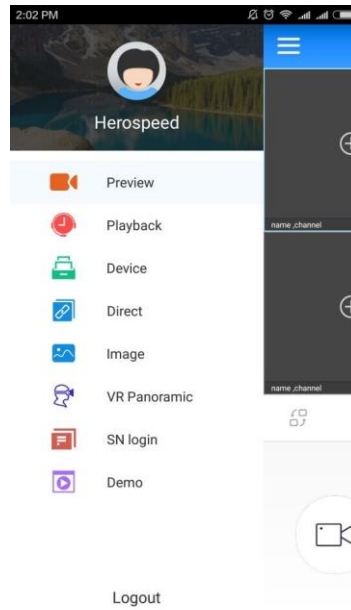

(3) In the device management interface, Click **【Add Device】** or **【+】** on the right of Device Management to enter the adding devices interface.

(4) Scan the QR code on the gift box or on the website to add the device.

(5) Enter the device's user name and password, and then click **【Submit】**

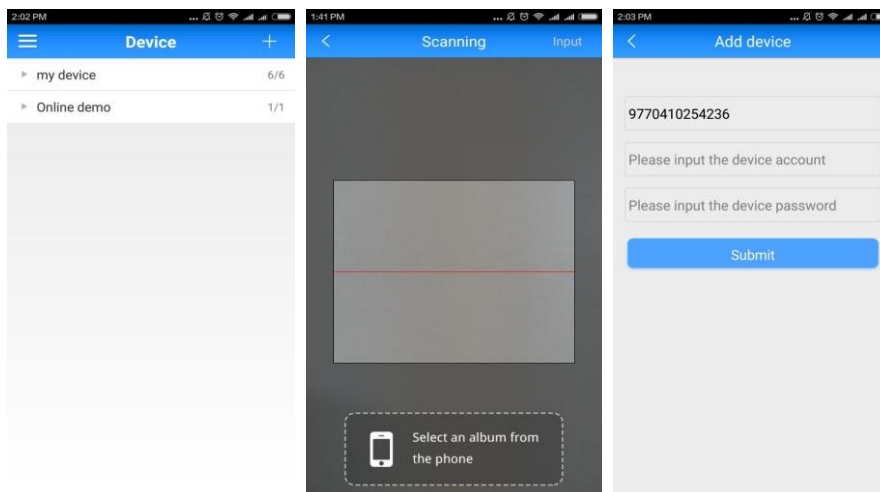

5.3. VR Preview

Preview the real time stream of the fisheye camera.

Steps:

(1) Enter the sliding menu, Click **【VR】** to preview .

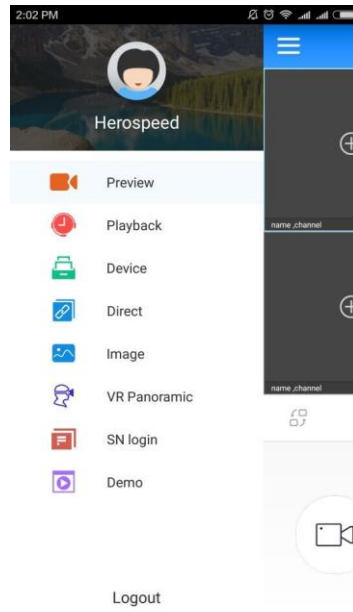

(2) Click **【+】**

(3) In **【My device】**, please choose the device you want to preview, then click **【Preview】**

(4) You can select different preview modes in the preview interface, different modes as below.

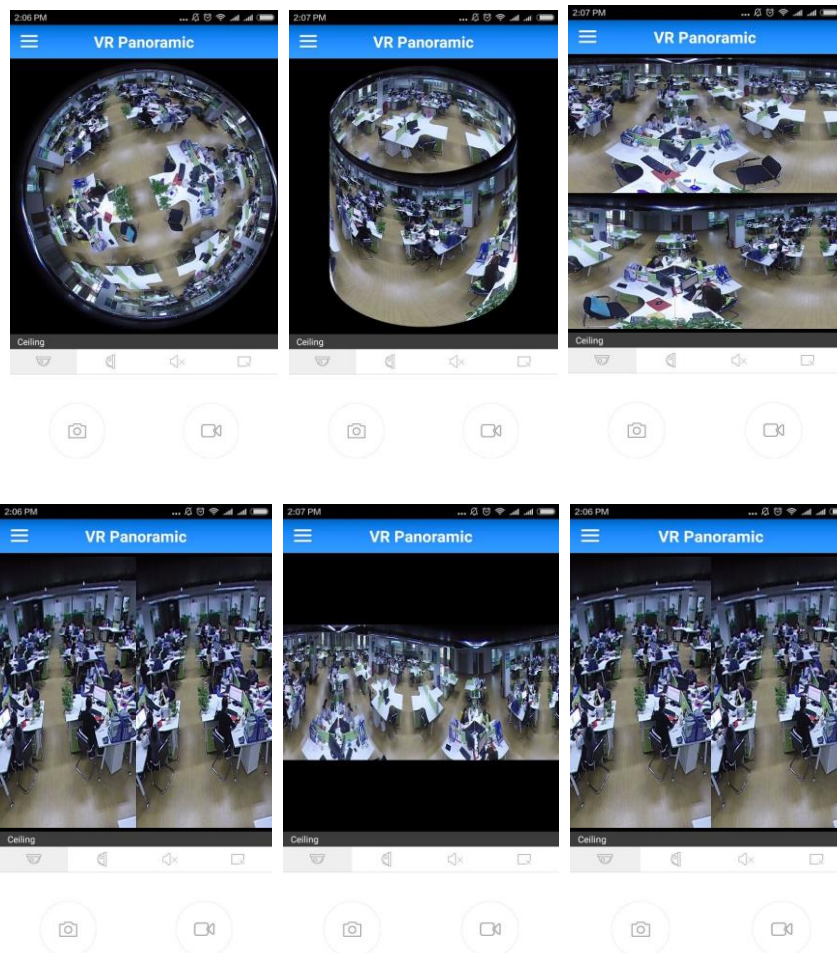

In the VR preview interface, you can switch preview mode, video, capture, set the sound and so on.

6. Frequently Asked Questions

6.1. Why not access the camera by IE?

Answer: There maybe 3 reasons, Details are as follows:

a.The network unreasonable?

Solution: First you can connect network by PC, check the network cable if it is good. And check the network between the camera and the PC is good.

b.The IP address of the camera is occupied by other device or PC?

Solution: You can connect the camera with your PC directly, and modify the IP address or use the IP search tool.

c.The camera maybe in other network segment?

Solution: Check the IP address and net mask.

6.2. Why can not access the camera after update?

Answer: Clean browser cache.

Steps: open IE, click "Tools" and select "Internet Options", then you can see "Temporary Internet files" and click "Delete Files", it will prompt a dialog you need to check "Delete all offline content" and click "OK".

Also you can click "Start" and select "Run" then enter "cmd", enter "arp -d" in "Command Prompt" interface. Re-access the camera.

6.3. Why cannot show the whole interface?

Answer: Close some options of IE.

Steps: Open IE, click "View" and select "Toolbar", close the "Favorites bar", "Status bar" and "Command bar".